



# SAPPHIRE™

bingo console



# Operators Manual

[www.bingoking.com](http://www.bingoking.com)

# **Sapphire Bingo Console Operator's Manual**

**Version 1.2**

**February 2007**

**©2007 Bingo King Co. All Rights Reserved.**

**Bingo King Co.  
2807 Lincoln Way  
Lynnwood, WA 98087  
phone: 425.745.3700**

# Table of Contents

<b>1. Unpacking.....</b>	<b>1</b>
Flashboard.....	2
Console.....	3
Bingo Balls.....	4
Warranty Assurance.....	4
<b>2. Installation.....</b>	<b>5</b>
Console Installation.....	5
Monitor Installation.....	5
Console Electrical.....	7
Flashboard Connection/Installation.....	8
Optional Printer Installation.....	9
Optional Video Installation.....	10
Monitors.....	10
Televisions.....	11
Connector Types.....	12
RF Modulator Video Connections.....	13
<b>3. System Programming.....</b>	<b>14</b>
Keypad Layout Reference.....	14
Keypad Programming Reference.....	15
System Setup.....	16
Creating a Game Pattern.....	17
Programming an Individual Game Pattern.....	17
Programming an Automatic Complex Game Pattern.....	19
Programming a Manual Complex Game Pattern.....	21
Programming a Session.....	22
Preprogrammed Game Patterns.....	23
Operator's Game Pattern Worksheets.....	27
Session Programming Worksheets.....	33
<b>4. Playing Sessions and Games.....</b>	<b>38</b>
Playing a Bingo Game.....	38
Manual Games.....	39
Preprogrammed Session.....	39
Changing Preprogrammed Game Data.....	41
Canceling a Ball.....	41
Verifying a Bingo.....	42
<b>5. Special Functions.....</b>	<b>44</b>
Testing the System.....	44
Entering a Wild Number.....	44
Bonanza Save and Recall.....	45
Delete Winning Pattern.....	45

<b>5. Special Functions (cont'd)</b> .....	<b>44</b>
Game Recall (Resume Previous Game).....	45
Speed Bingo .....	46
Printer Option .....	46
Time and Date Programming .....	48
Programming the Date.....	48
Programming the Time.....	48
Changing Ball Timer Mode .....	49
Constant Timer Mode .....	49
Ball-Activated Mode .....	49
Random Number Generator (Auto Call or Manual Mode).....	50
Auto Call Operation .....	50
Manual Mode Operation.....	50
<b>6. Customer Servicing .....</b>	<b>51</b>
Cleaning .....	51
Console Laminated and Painted Surfaces .....	51
Console and Flashboard Acrylic Surfaces .....	51
Bingo Balls .....	51
Static Treatment.....	52
Changing Light Bulbs .....	52
Mixing Chamber Light Bulb.....	52
Accessing 4" Flashboard Lamps.....	53
Accessing 8" Flashboard Lamps.....	54
Changing Flashboard Light Bulbs .....	55
Blower and Mixer Maintenance .....	56
Console Air Filter Replacement.....	57
Resetting the Console Circuit Breakers .....	58
<b>7. Troubleshooting .....</b>	<b>59</b>
Blower Motor Troubleshooting .....	59
Blower Stopped Working.....	59
Blower Operates Slowly .....	59
Mixer Motor Troubleshooting .....	60
Mixer Motor Stopped Working.....	60
Mixer Motor Running Slow .....	60
Flashboard Output Problems.....	60
Flashboard Lights Flicker .....	60
No Flashboard Response.....	61
<b>8. Wiring Diagrams and PCB Layouts .....</b>	<b>62</b>
I/O Box Front Connections .....	62
I/O Box, Rear Connections .....	63
I/O Box, Top Connections .....	64
BVS PCB .....	65
BK1BC PCB .....	66
BK2BC PCB .....	67
AVA PCB .....	68
<b>9. Warranty.....</b>	<b>69</b>

# Unpacking

## Chapter

# 1

The Bingo King Co. designed the Sapphire Bingo Console to have a distinctively attractive appearance, and we used careful manufacturing and assembly techniques to preserve this appearance. Each Sapphire Bingo Console is inspected for scratches, bumps or abrasions during packing, and is warranted to be free from defects.

### DAMAGE ACTION PROCESS

Your Bingo King Co. equipment contains delicate electronic equipment. It is imperative that you thoroughly inspect the contents of the package before accepting product delivery from the carrier.

In case of severe damage, refuse the equipment from the carrier. Contact your local Bingo King distributor for immediate replacement.

If the product is damaged but acceptable, make a note on the bill of lading before accepting. Take a photo of the damage before and after unpacking as a record of claim against the carrier. Contact the carrier's agent immediately for inspection. Be sure to obtain a copy of the inspection report for your records.

If these precautions are not taken, we cannot assist you in recovering the amount of the claim against the carrier.

### CAUTION:

Please take great care when unpacking the console and flashboard from the packing material. Cutting the packing material too aggressively may lead to console or flashboard damage.

## Flashboard

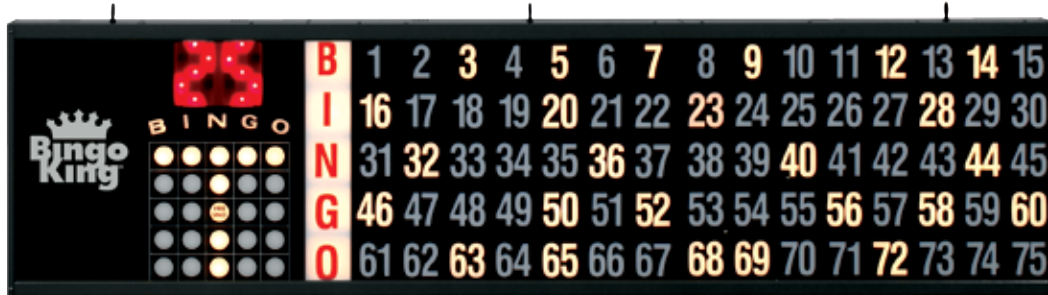

The flashboard is banded into a heavy cardboard enclosure with foam inserts at each end and in the middle. This carton is marked with various warning labels and stampings. Lay the carton flat, observing that the outside overlapping cover of the flashboard is on the top side.

Before opening, closely inspect the carton for evidence of shipping damage such as puncture holes, tears, and crushed edges or corners. Damage to the carton may mean damage to the flashboard. If damage is detected refer to the Damage Action Process section (page 1) for procedures.

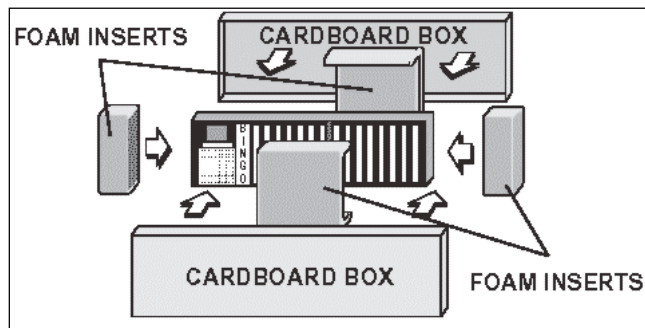

Use scissors to cut all straps. Carefully lift off the carton top. Cut the tape on the four corners of the carton bottom and the retaining tape on the center foam insert then lay the carton flaps down flat. Slide both ends and the top center foam pieces off to allow access to the flashboard. To prevent scratches, make sure the flashboard remains on the cardboard prior to actual installation. Obtain assistance in setting the flashboard upright.

### CAUTION:

Do not destroy or discard carton materials until after final inspection and testing.

## Console

The Sapphire Bingo Console is packed with foam protectors in a cardboard carton and is skid mounted. Once again, check the carton for possible signs of damage. If damage is detected, refer to the Damage Action Process section (page 1) for procedures.

### CAUTION:

The console weighs approximately 225 pounds. Please obtain help before lifting. A minimum of two individuals is required for proper unpacking.



Use scissors to cut the straps from the skid only, taking care not to cut the straps protecting the console. With the help of at least one assistant, carefully lift the console from the skid and place it on solid flooring. Cut the remaining four straps from the console and remove the cardboard top.

The monitor will be safely tucked in the caller's foot well and should be removed and set aside. This will be needed later to finish the setting up the console. For now, leave it in its protective box to protect the screen from damage.

Remove the two foam protectors inside the top and slide the cardboard tube up and off the console. A minimum of two people are required to safely unpack the console. With one person lifting from the top of the ball-blower end and another individual grasping the opposite console end, raise the console up and out from the carton and foam inserts. Check that all casters are in place. Set unpacked console on solid flooring. Do not destroy or discard carton material until after final inspection and testing.

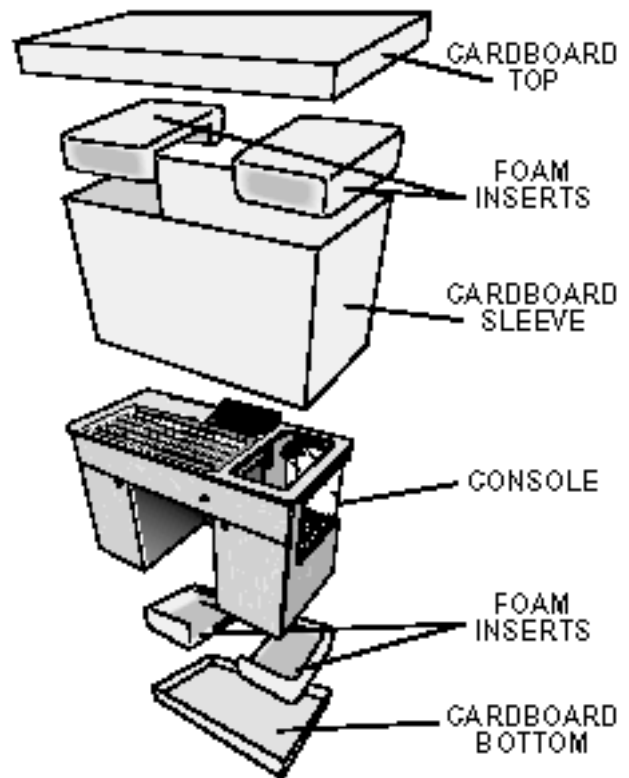

At this point you should inspect the console for shipping damage. All acrylic panels should be in place. Metal panels and their associated switches and parts should be operational. If problems are found in any of these areas, immediately contact your distributor for advice and refer to the Damage Action Process section (page 1) for procedures.

## **Bingo Balls**

Open the box of bingo balls, check each ball for damage and insert each ball into its corresponding slot in the console ball tray. If a ball has a flat spot, immerse it in hot water for a short period of time and it should “pop” back into position. If it does not “pop” back into shape, please contact your distributor for a replacement.



## **Warranty Assurance**

You must keep a copy of your receipt or invoice for proof of purchase. Please review the warranty information on page 69 of this manual.

If there are any questions, contact your distributor or call Technical Assistance at:

**866-405-3482**



**TECHNICAL ASSISTANCE CENTER**

*Providing Proactive Solutions  
Through Quality Service and Support*

Support Hours: 8:00 AM to 12:00 AM EST

**866.405.3482 • [www.bingoking.com](http://www.bingoking.com)**



# Installation

## Console Installation

### Monitor Installation

Remove the monitor from its shipping container. Inspect the monitor for any apparent shipping damage.

If the monitor is damaged, please review the Damage Action Process on page 1.

Remove the screws from the back of the monitor. (This picture is of the monitor attached to the arm, but the screws are stored in the same position.)

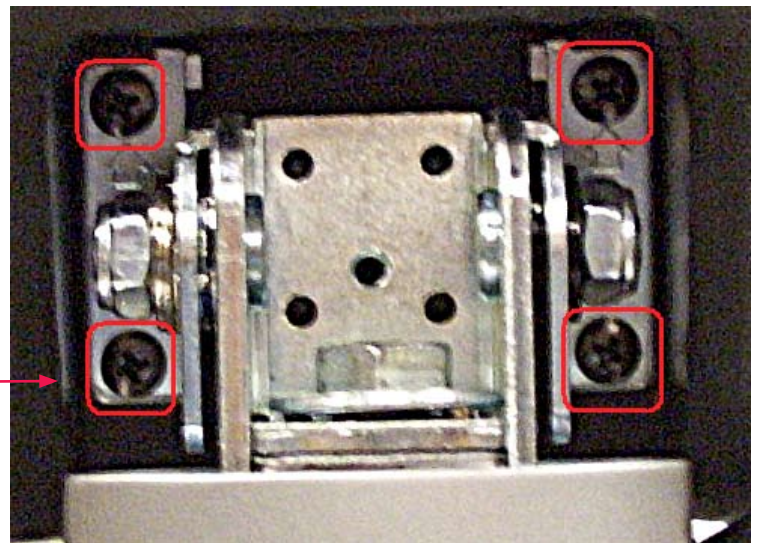

Remove the cover from the monitor arm on the console. There is a single Phillips head screw holding this in place.



Make sure the screws are in reach and then slide the monitor onto the arm making sure the monitor arm bracket is inserted into the monitor tabs, but don't let go of the monitor.

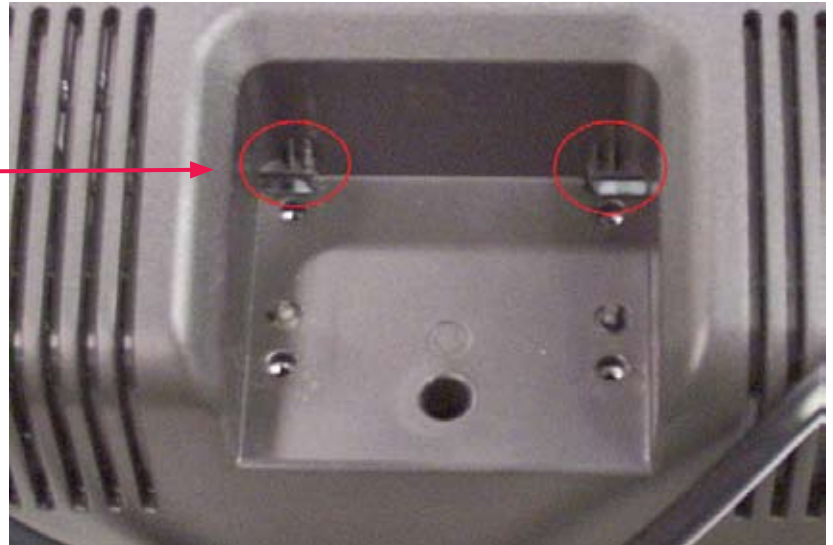

With your free hand, start the screws into the back of the monitor through the monitor arm.

**CAUTION:**

Please do not let go of the monitor until it is securely fastened onto the arm. The monitor may shift and release from the locking tabs causing damage to the monitor and possibly injuring yourself.

**CAUTION:**

Do not overtighten the screws! Start the screws by hand to assure the threads are lined up and then hand tighten for a snug fit. Overtightening may break the plastic and damage the monitor.

When the monitor is securely fastened to the monitor arm, reinstall the screw cover to the monitor arm. Again, please do not overtighten the screw.

## Console Electrical

Plug the bingo console and flashboard (s) into any 110/120 VAC 60HZ grounded power outlet.

### **CAUTION:**

Consoles and flashboards can draw a considerable amount of current. Be aware of how much current is on one circuit breaker to avoid nuisance trips on your circuit.

**All consoles are rated at 12 amps.**

### **Flashboards:**

Measurements Are In Amperes	Numbers Only	Game Indicator	Dollar Value
2"	3	3.75	5.25
4"	3	3.75	5.25
8"	5	6.5	9.5

## Flashboard Connection/Installation

Data connections for the Bingo flashboards are made with the console data cable output connectors, located on the Sapphire Input/Output panel, in the left hand compartment of the console. Utilize the gap between the bottom of the left hand console door and the bottom of the console to run the cables.

Install the flashboard data cable. When possible, we recommend using a one-piece cable avoiding splices, adapters and other mating devices. Wiring to the flashboard may be permanently installed using a wire mold. Where a permanent installation is not possible, install the flashboard data cable through the walls and/or ceiling to where the console can be rolled in and easily connected with all data and power cables.

You may have an installation that requires hook up of more than one flashboard. In such an instance, the second and subsequent flashboards may be daisy chained by connecting the data cable to the “ALT/OUTPUT” connection on the first flashboard to the “ALT/INPUT” connection on the second flashboard, and so on. This allows virtually an unlimited number of Bingo King flashboards to be added.

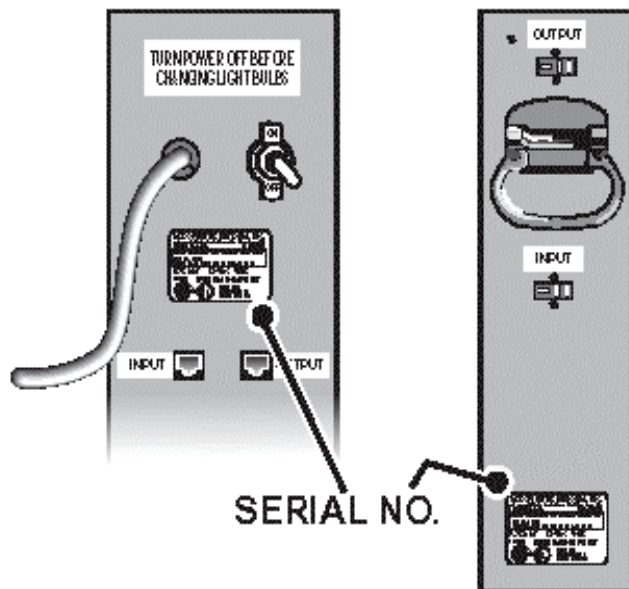

## Optional Printer Installation

### NOTE:

This is not a Bingo King supplied option. An Epson emulated printer would have to be purchased separately.

The connector marked “PARALLEL PRINTER” is a standard IBM® compatible dot matrix printer interface. Simply plug in any PC-compatible printer power cord and printer signal cable (please refer to the printer operating manual for proper instructions) and you are ready to run. Always keep the printer set to “ON LINE” to prevent any errors.

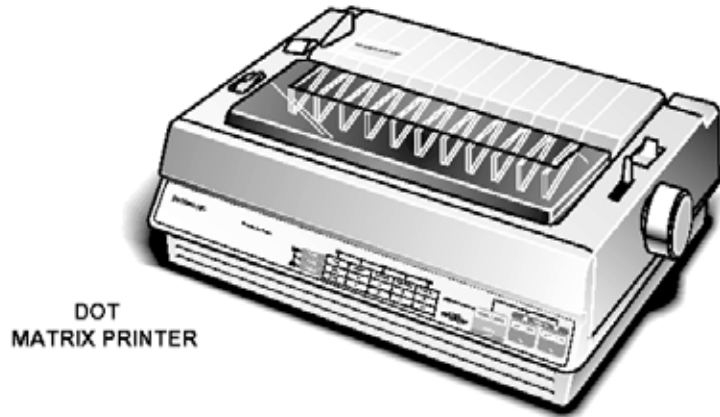

### NOTE:

The printer needs to be set for “Epson Emulation.”

## PRINTER CABLE

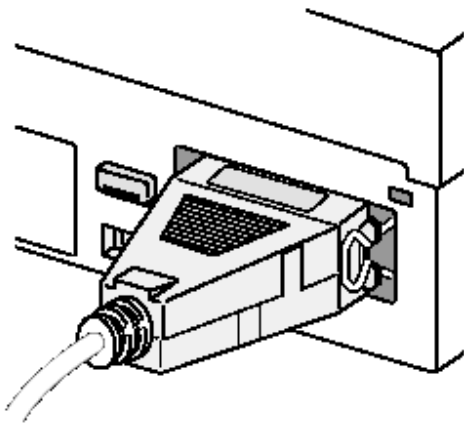

When using your printer, always keep paper installed in the printer and have an adequate paper supply on hand. While an “out of paper” error will not lock-up the system, you will lose valuable game log information if the printer runs out of paper and new paper is not inserted.

If you do not use the printer, either turn the printer power off or unplug the printer from the printer signal connector.

Refer to the owner’s manual of your specific printer for additional information.

## Optional Video Installation

The BNC-type connector on top of the console marked “CAMERA INPUT” is used with any camera having a standard composite video output. Use a high-quality RG 59U video cable with BNC connections, plug one end into the “CAMERA INPUT” connector on the video input panel which is located behind the ball catcher, and connect the other end to the “VIDEO OUTPUT” connector on the camera. The RCA jack labeled DC power is just a feed through for DC powered cameras. It may, at time of order, optionally be wired for a factory installed color camera.

### Monitors:

Monitors and TV/Monitors receive the line level composite signal through coax (RG6 or RG59) cable typically using either a BNC or RCA style connector for input. There may or may not be an output connector. If there is an output connector there usually is an impedance switch. If using multiple monitors, connect a cable from the BNC connector labeled “Hall Monitor Output” for ball display. Connect the other end to the “Input” on the first monitor. Next run a cable from the “Video Output” of the first monitor to the “Video Input” on the second monitor and so on. Set all monitors to High Impedance with DC restoration off. Set the last monitor’s impedance switch to 75 ohm. A video distribution amp may be required if the run exceeds 800 feet of cable or the monitors do not have a Video Output. The cable should be routed away from any obstructions or public walkways.

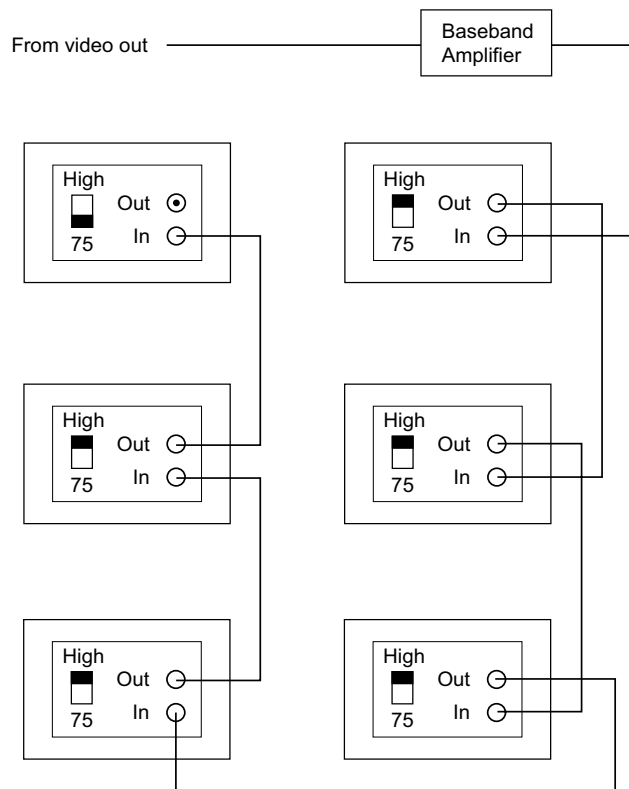

The video monitor layout is the simplest and highest quality.

The wiring and amplifier connections are daisy-chained. It is easy to install and troubleshoot. Don't forget to terminate the last monitor as shown.

Use only RG-59/U 75 Ohm coaxial cable

No more than 400 ft. between amps or amp to end.

**Televisions:**

Televisions and TV/Monitors receive the RF signal through coax (RG6 or RG59) cable, typically using an F connector for input. The connector is usually labeled “Antenna.” RF amplifiers may be required when using five or more televisions. The video cable should be routed away from obstructions or public walkways. If using multiple TVs, a signal splitter may be used.

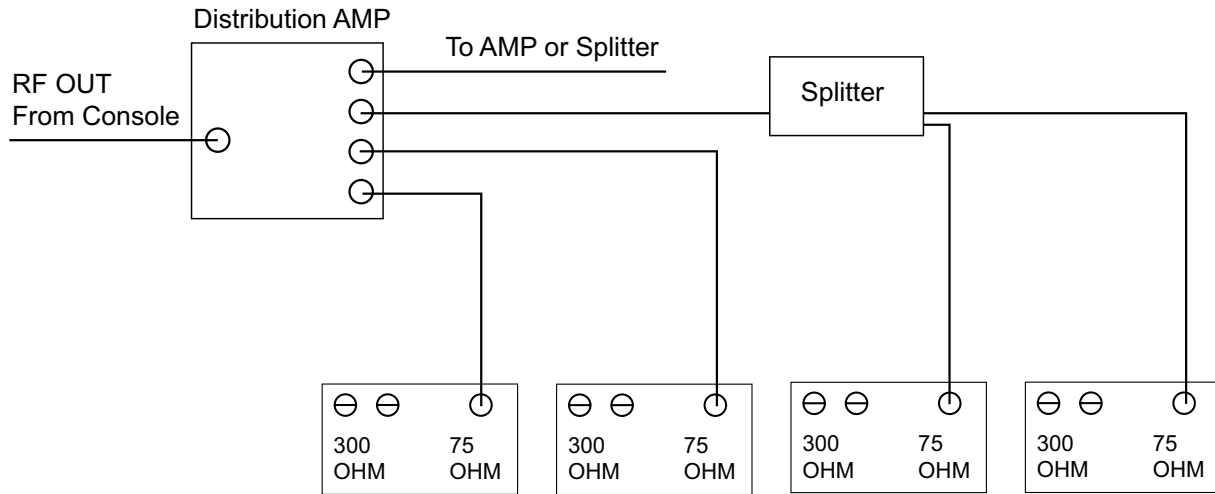

Layout shown is typical of TV installations. If your TVs do not have a “cable” type antenna input, you can add a coax to spade adapter and connect to the TVs’ 300 OHM spade terminals.

Plug one end of the cable into the “Hall Monitor Output” connector on the I/O panel inside the left hand door. Plug the other end of the cable into the “Video Input” of an RF Modulator. The RF output can now be used to run your standard TVs. If using only one television the RF output will plug into “Antenna” input on the television. When using multiple TVs the RF output will plug into the input on an RF Splitter or distribution amplifier. The outputs of the RF Splitter/amplifier will go to “Antenna” on the hall TVs.

# Connector Types

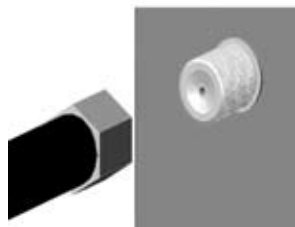
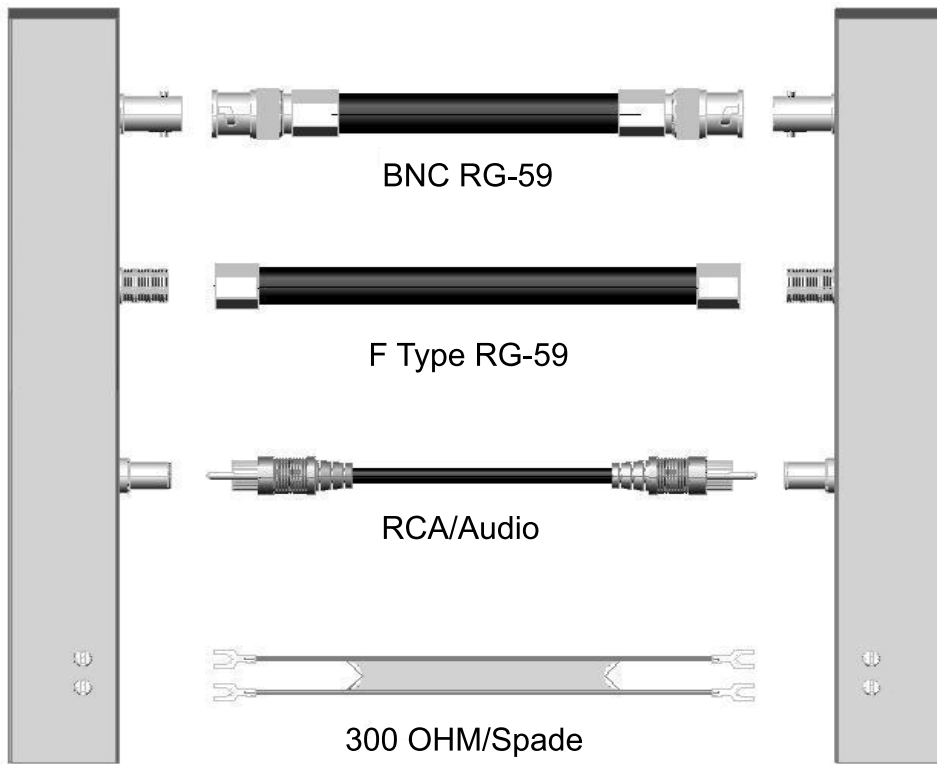

F-Type



BNC



RCA



300 OHM Spade



## RF Modulator Video Connections

Ensure that the televisions are set to the same channel as the RF modulator; normally channel 3 or 4.

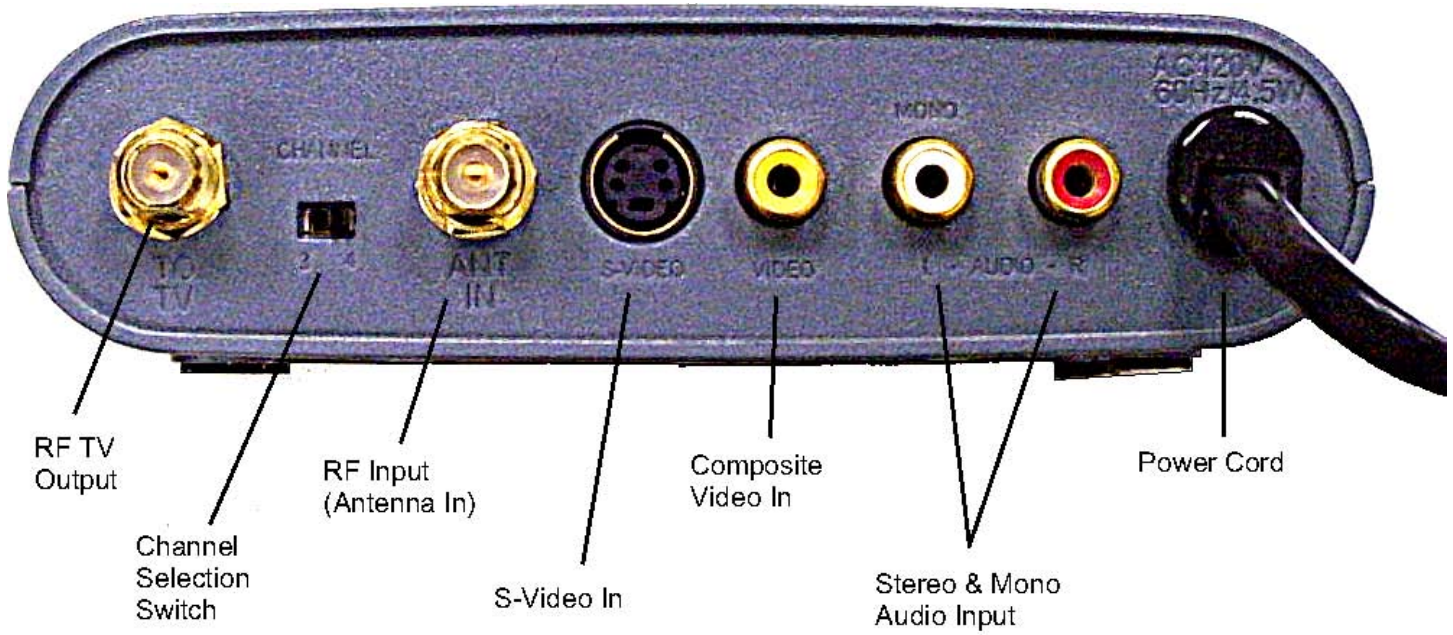

# System Programming

# Chapter 3

## Keypad Layout Reference

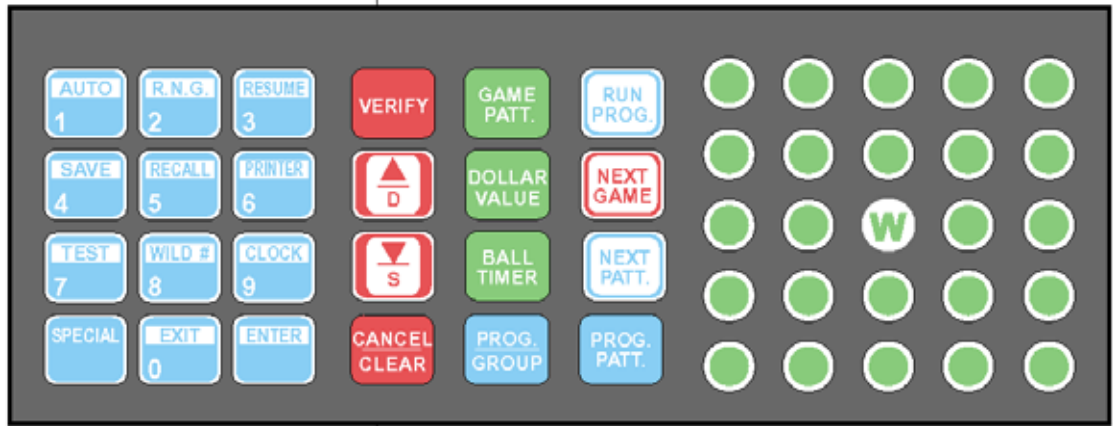

FUNCTION	KEY SEQUENCE
Clear All Memory	Special – Cancel/Clear – W – 2 – 4 – 6 – 4 – 6
Select Constant Timer Mode	Special – Auto – Enter: (Alternates w/Ball-Act. Timer)
Select Ball Activated Mode	Special – Auto – Enter: (Alternates w/Constant Timer)
Random Number Generator (optional)	Special – RNG – (number of balls to be called) – Enter
Save Bonanza Game	Special – Save – Enter
Recall Bonanza Game	Special – Recall – Enter
Test Flashboards	Special – Test
Wild-Number Entry	Special – Wild # – (menu options) – Special – Exit
Set Time	Special – Clock – Enter – (hour) _ Enter – (minutes) – Enter
Set Date	Special – Clock – D – (month) – Enter – (day) – Enter – (year) – Enter
Leave Session or Resume Manual Mode	Special – Exit – Enter: (to leave session) Special – Exit – Cancel/Clear: (to resume current session)
Cancel a Call	Cancel/Clear – (number of ball to be cancelled) – Enter
Instant Game Pattern	Game Patt. – Enter – (game pattern keys) – Enter
Resume Prev. Game	Special – Resume: (only in auto mode)

## Keypad Programming Reference

### NOTE:

For VERIFY functions, see page 42 for details.

FUNCTION	KEY SEQUENCE
Program Session	Prog./Group — (session number) — Enter — (game number) — Enter
Game Pattern Select	Game Patt. — (game pattern number) — Enter
Dollar Value	Dollar Value — (dollar value) — Enter
Ball Timer	Ball Timer — (number of seconds) — Enter
Next Game	Next Game — Enter
Leave Program Session	Special — Exit — Enter
Next Pattern	Next Pattern
Run Pre-Programmed Session	Run Prog. — (session number) — Enter — (game number) — Enter
Program Individual Pattern	Prog. Patt. — Enter — (game pattern number) — Enter — [(game pattern keys) — Next Patt.] — Prog. Patt.
Program Manual Complex Game Pattern	Prog. Patt. — Special — (game pattern number) — Enter — [(game pattern keys) — Next Patt.] — Prog. Patt.
Program Automatic Complex Game Pattern	Prog. Patt. — Prog./Group — (game pattern number) — Enter — [(game pattern keys) — Next Patt.] — Prog. Patt. — number of building block multiples — Enter

## System Setup

### NOTE:

This is only required for initial installation or when changing configuration.



Turn the "POWER" switch on.

The display will read:



SAPPHIRE BINGO SYSTEM  
BY BINGO KING CO.  
EQUIPMENT VER BKV5.0  
COPYRIGHT 2006, 2007

PRESS 'ENTER' TO START  
THE GAME, OR USE THE  
'RUN PROG' KEY TO START  
A BINGO SESSION



Press the "ENTER" key.



Press the "SPECIAL" key,  
followed by the "S" key.

The display will read:



\*\* SETUP SYSTEM \*\*  
ENTER PASSWORD

Enter the system password: 2 4 6 4 6  
using the numeric keypad.

Now the various SETUP items can be changed/set, such as ball tray size, setting RNG operation, verify on last ball, flashboard configuration, etc.

## Creating a Game Pattern

### Programming an Individual Game Pattern

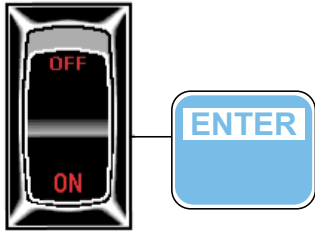

POWER

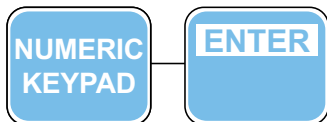
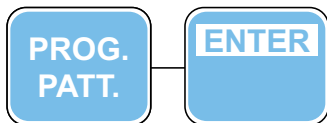

**NOTE:** If you press the wrong button when creating the bingo face, simply press the same button again to erase your mistake.

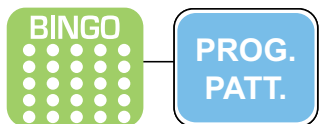
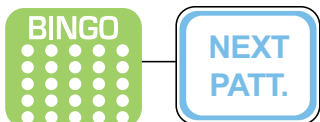

1. Turn the 'POWER' switch on.
2. Press the 'ENTER' key.
3. Press the 'PROG. PATT.' key.
4. Press the 'ENTER' key to program individual game pattern(s).
5. Enter a game pattern number between 101-200.
6. Press the 'ENTER' key.
7. Using the BINGO face keypad, type in the desired game pattern. Refer to note.
8. Press the 'NEXT PATT.' key to enter up to 45 possible winning game pattern combinations.
9. Using the BINGO face keypad, type in the next desired pattern. Refer to note. (Repeat steps #8 and #9 until the desired number of game patterns have been programmed.)
10. Press the 'PROG. PATT.' key to save the created game pattern(s).
11. Record your newly created game pattern(s) on your game pattern worksheets (page 27) for future reference.
12. To view or review previously programmed game patterns, press 'GAME PATT.' key followed by game pattern number using the numeric keypad and then following with the 'ENTER' key.

#### **NOTE:**

If entering a game pattern with up to 45 multiple winning patterns, all possible winning combinations must be entered at this time. For game patterns with more than 45 multiple winning games patterns, use a manual complex pattern. (page 21)

## Individual Game Pattern Example



a. Press the 'PROG. PATT.' key.

b. Press the 'ENTER' key.

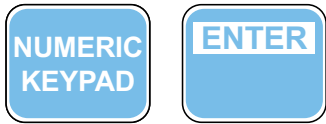

c. Enter a game pattern number between 101-200 using the numeric keypad.

d. Press the 'ENTER' key.



e. Press in “” pattern on the BINGO face keypad.

f. Press the 'NEXT PATT.' key.

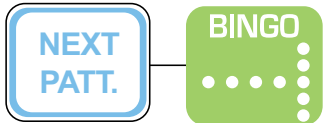

g. Press in “” pattern on the BINGO face keypad.

h. Press the 'NEXT PATT.' key.

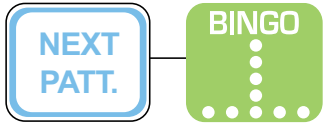

i. Press in “” pattern on the BINGO face keypad.

j. Press the 'NEXT PATT.' key.

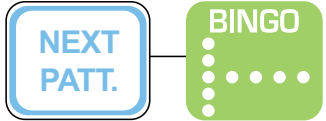

k. Press in “” pattern on the BINGO face keypad.

l. Press the 'PROG. PATT.' to save the game pattern.



## Programming an Automatic Complex Game Pattern

(Such as a double, triple, or quad bingo pattern)

### CAUTION:

You can only have a pattern with a total of 400 combinations. This means that there is a limit on the number of building blocks you can use: 28 building blocks for a double, 14 building blocks for a triple, and 11 building blocks for a quadruple bingo.

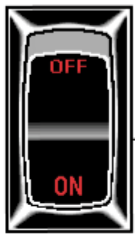

POWER

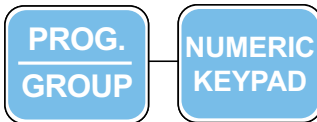
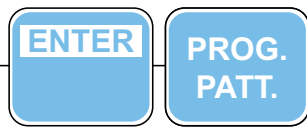

1. Turn the 'POWER' switch on.
2. Press the 'ENTER' key.
3. Press the 'PROG. PATT.' key.
4. Press the 'PROG./GROUP' key.
5. Enter a game pattern number between 201-240 using the numeric keypad.
6. Press the 'ENTER' key.
7. Enter in the first modular game pattern building block using the game pattern keypad.
8. Press the 'NEXT PATT.' key.

## Programming an Automatic Complex Game Pattern (cont'd)

### NOTE:

We're only concerned about the single bingo patterns that comprise this pattern right now. In the next few steps, we'll tell the computer to combine all the patterns you've entered to calculate your double, triple, or quad bingo.

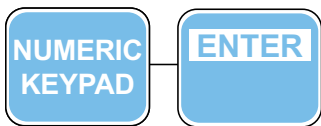

9. Continue entering the building blocks (steps #7 & #8) until complete. Refer to note above.
10. Press the 'PROG PATT.' key.
11. Press "2" for a double, "3" for a triple or "4" for a quadruple bingo.
12. Press the 'ENTER' key to calculate potential winning game pattern combinations.
13. Press the 'ENTER' key to return to the manual game screen.
14. Record your newly created game pattern(s) on your game pattern worksheets for future reference. (page 27)
15. To view or review previously programmed game patterns, press the 'GAME PATT.' key followed by the game pattern number using the numeric keypad then follow with the 'ENTER' key.



## Programming a Manual Complex Game Pattern

### NOTE:

Use the manual complex game pattern to program patterns that may require more than the 45 available patterns in a individual game pattern program. You can have up to 400 game patterns with this option.

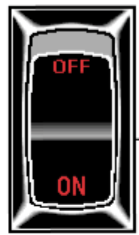

POWER



1. Turn the 'POWER' switch on.
2. Press the 'ENTER' key.
3. Press the 'PROG. PATT.' key.
4. Press the 'SPECIAL' key.
5. Enter a game pattern number between 201-240 using the numeric keypad.
6. Press the 'ENTER' key.
7. Enter in the first game pattern using the game pattern keypad.
8. Press the 'NEXT PATT.' key.
9. Continue entering the game patterns followed by the 'NEXT PATT.' key (steps #7 & #8) until complete.
10. Press the 'PROG. PATT.' key to save your newly created game pattern(s).
11. Record your newly created game pattern(s) on your game pattern worksheets for future reference. (page 27)
12. To view or review previously programmed game pattern(s), press the 'GAME PATT.' key followed by the game pattern number.

## Programming a Session

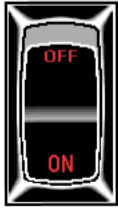

POWER

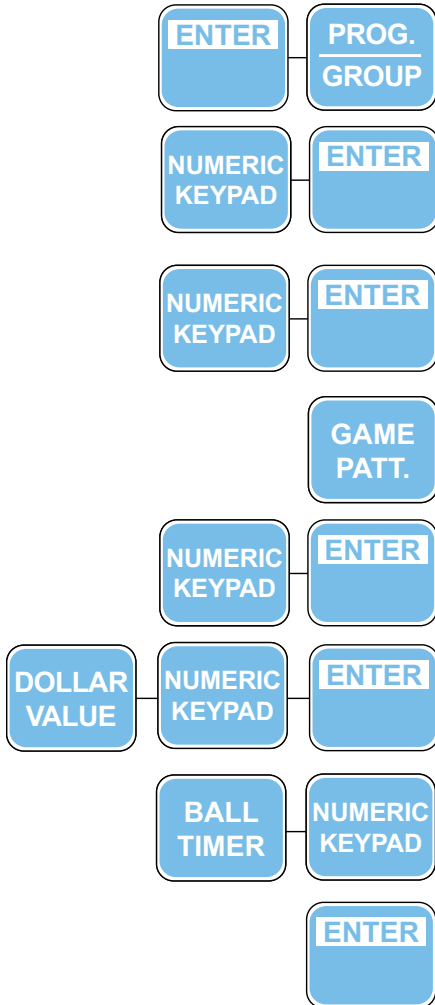

1. Turn the 'POWER' switch on.
2. Press the 'ENTER' key.
3. Press the 'PROG./GROUP' key.
4. Type in your desired session number between 1-20 using the numeric keypad. If you are programming a new session, enter "1" to begin with the first session.
5. Press the 'ENTER' key.
6. Type in your desired game number between 1-50 using the numeric keypad. If you are programming a new session, enter "1" to begin with the first game in that session.
7. Press the 'ENTER' key.
8. Press the 'GAME PATT.' key.
9. Type in a game pattern number from 1-240 using the numeric keypad.
10. Press the 'ENTER' key.
11. Press the 'DOLLAR VALUE' key.
12. Type in your payout using the numeric keypad (i.e. for a \$50.00 payout, type "5" - "0")
13. Press the 'ENTER' key.
14. Press the 'BALL TIMER' key.
15. Type in the desired time interval between the calling of a ball from 1-99 using the numeric keypad. (i. e. for 15 seconds type "1" and "5".)
16. Press the 'ENTER' key.
17. If you are programming a progressive game (one that has more than one game pattern, payout and or ball timer), all of this information must be entered now. Hit 'NEXT PATT.' and then go back to step #8 and continue until all game information is programmed.
18. Press the 'NEXT GAME' key to program the next game in your session. Continue starting with step #8 for each game in your session.
19. Press the 'SPECIAL' key to save your programming.
20. Press the 'EXIT' key to exit the session and return to the manual game screen.

## Preprogrammed Game Patterns

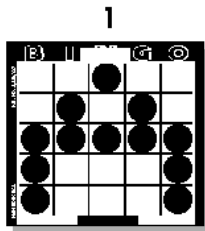

Letter A

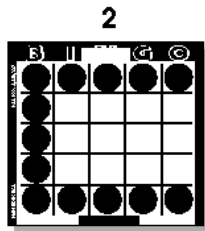

Letter C

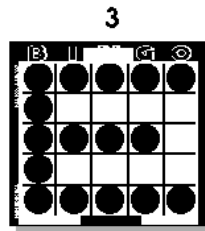

Letter E

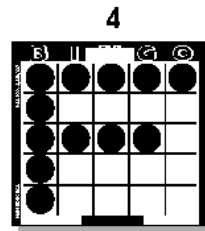

Letter F

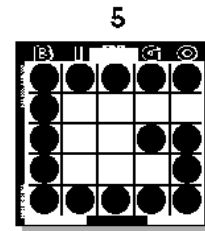

Letter G

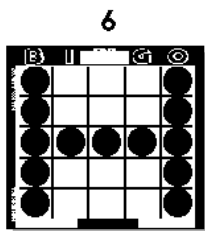

Letter H

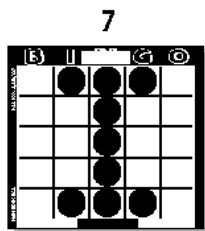

Letter I

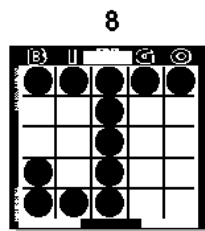

Letter J

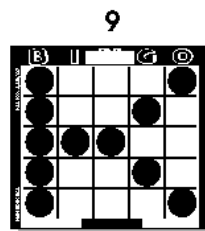

Letter K

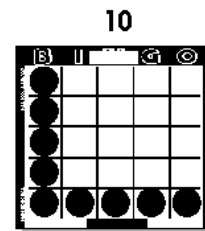

Letter L

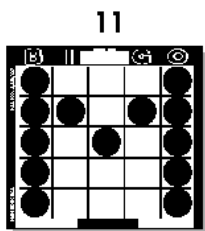

Letter M

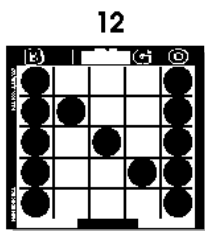

Letter N

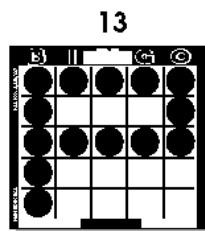

Letter P

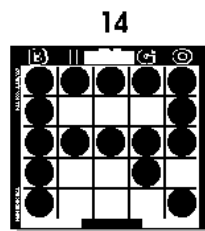

Letter R

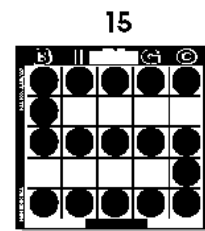

Letter S

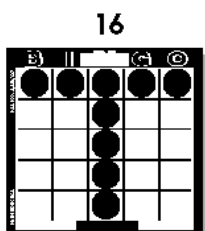

Letter T

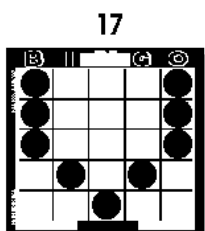

Letter V

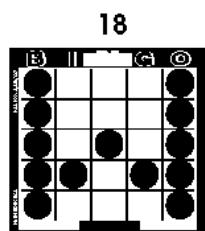

Letter W

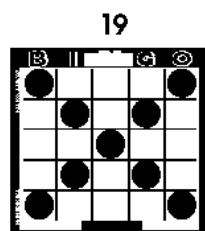

Letter X

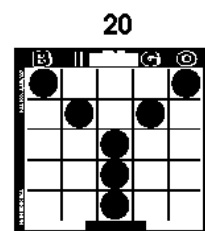

Letter Y

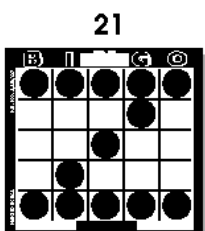

Letter Z

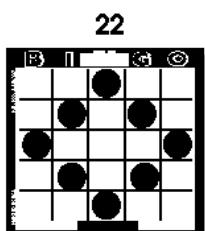

Large  
Diamond

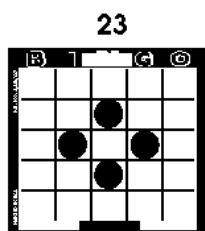

Small  
Diamond

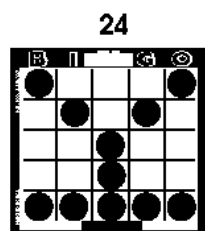

Empty  
Glass

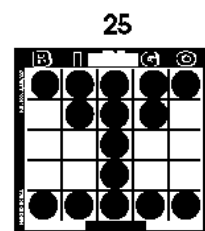

Full  
Glass

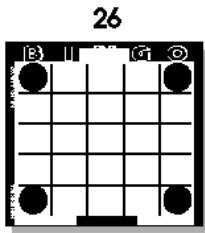

26  
Outside  
Four  
Corners

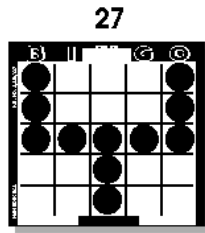

27  
Goal  
Post

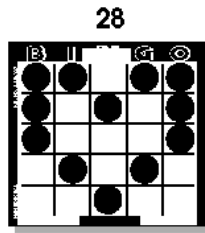

28  
Heart

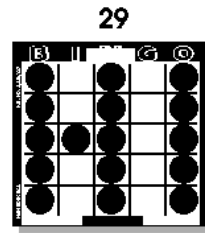

29  
Hi

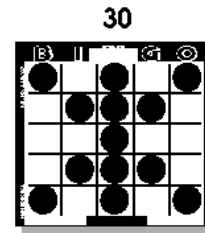

30  
Indian  
Star

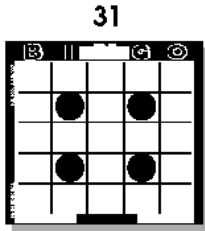

31  
Inside  
Four  
Corners

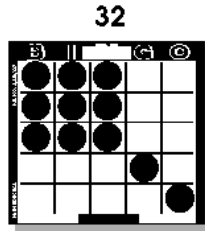

32  
Large  
Kite

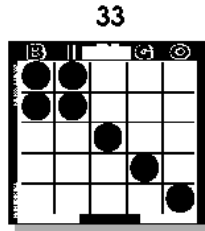

33  
Small  
Kite

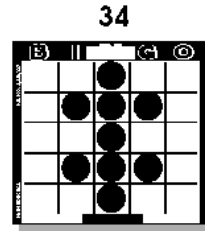

34  
Double  
Cross

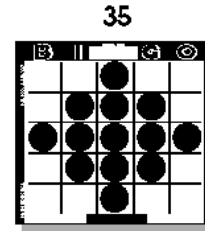

35  
Full  
Diamond

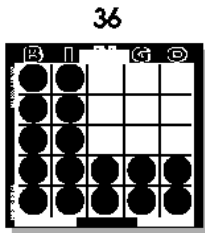

36  
Corner  
Stone

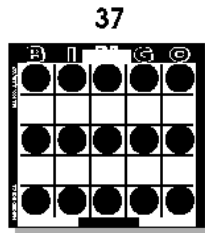

37  
Layer  
Cake

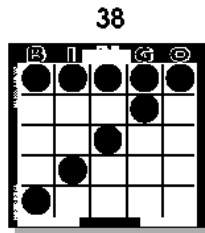

38  
Lucky 7

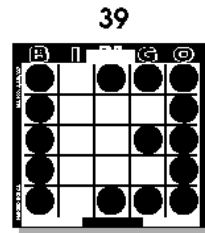

39  
Lucky  
13

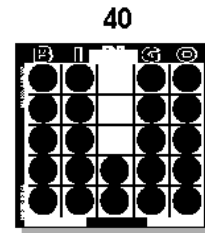

40  
Moat

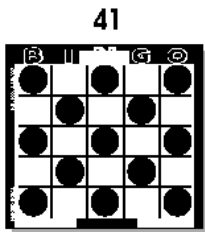

41  
Plaid

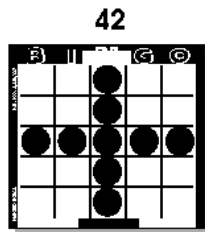

42  
Plus

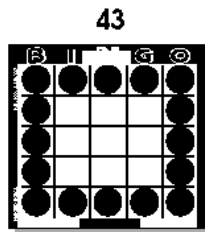

43  
Outside  
Picture  
Frame

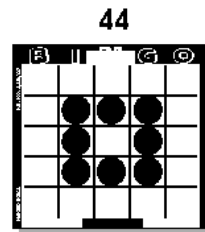

44  
Inside  
Picture  
Frame

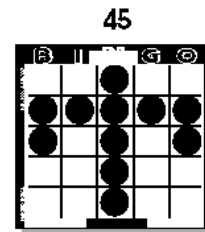

45  
Thunder  
Bird

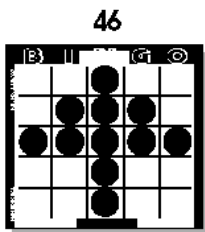

46  
Xmas  
Tree

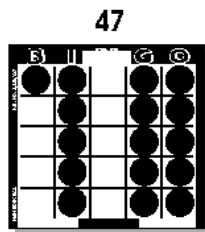

47  
7-11

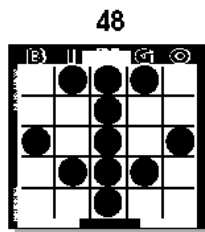

48  
Anchor

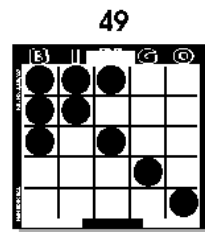

49  
Arrow 1

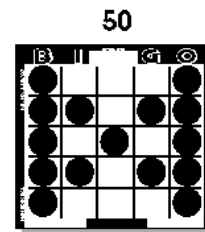

50  
Butterfly

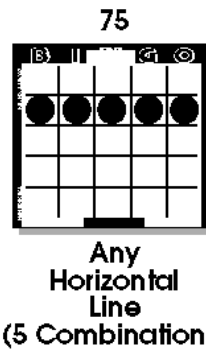
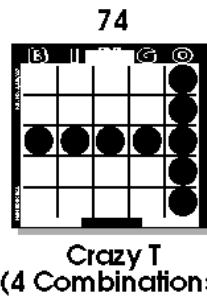
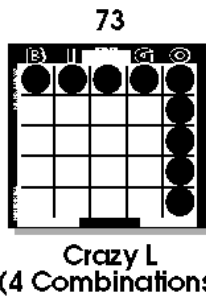
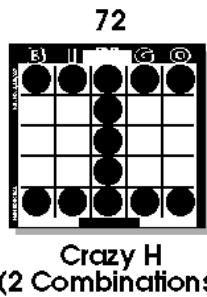
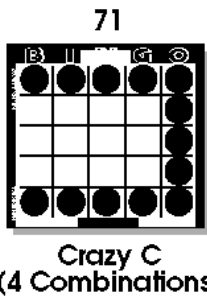
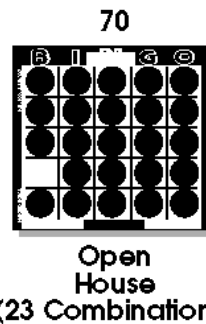
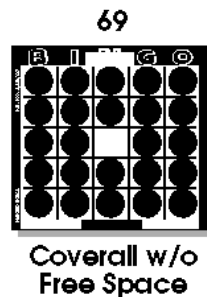
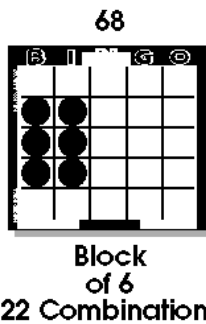
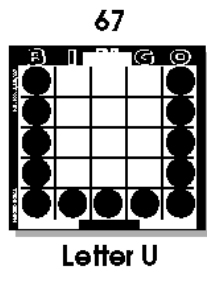
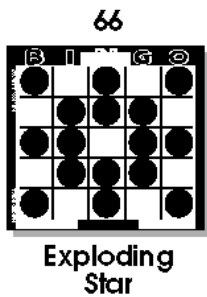
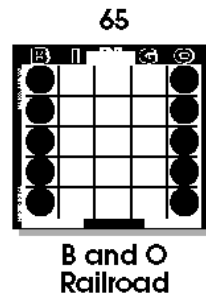
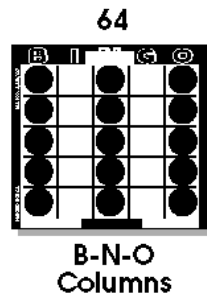
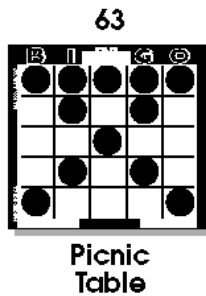
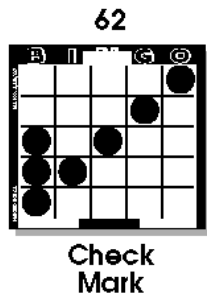
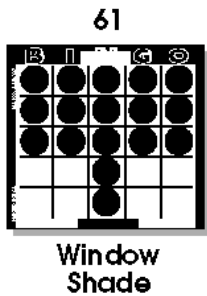
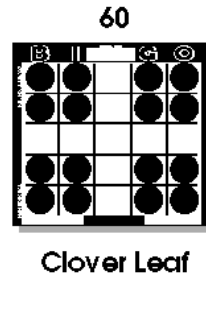
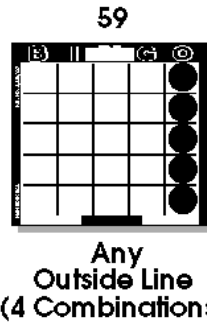
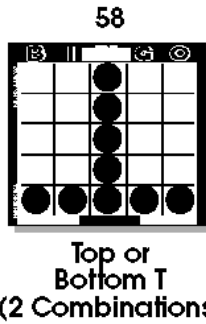
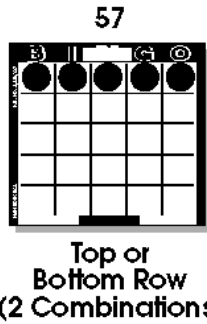
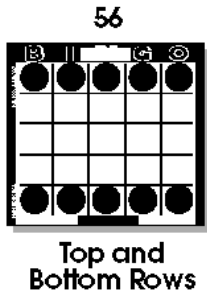
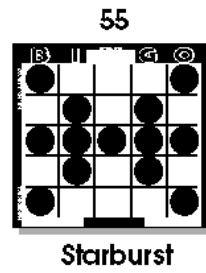
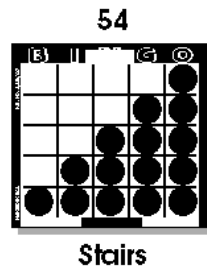
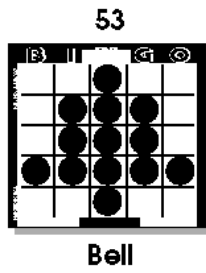
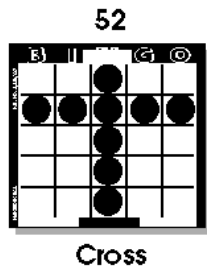
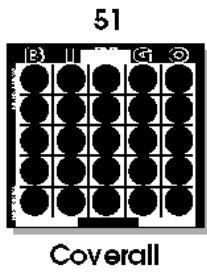

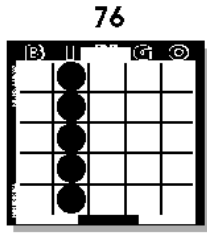

76  
Any Vertical Line  
(5 Combinations)

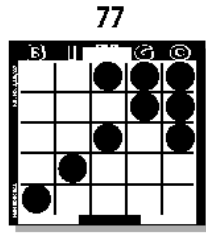

77  
Crazy Arrow  
(4 Combinations)

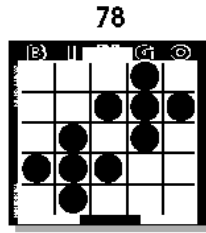

78  
Double Plus  
(2 Combinations)

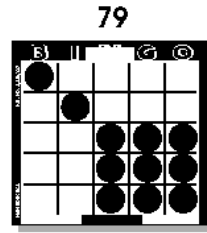

79  
Crazy Large Kite  
(4 Combinations)

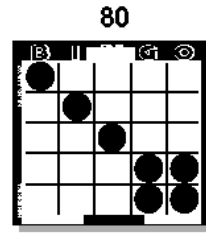

80  
Crazy Small Kite  
(4 Combinations)

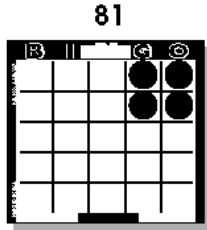

81  
Postage Stamp  
(4 Combinations)

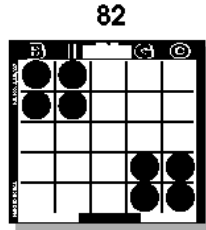

82  
Double Stamp  
(6 Combinations)

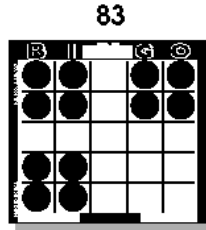

83  
Triple Stamp  
(4 Combinations)

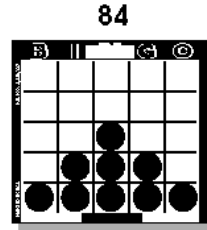

84  
Crazy Pyramid  
(4 Combinations)

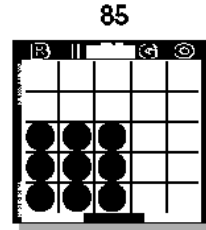

85  
Block of Nine  
(9 Combinations)

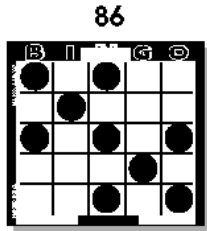

86  
Double X  
(2 Combinations)

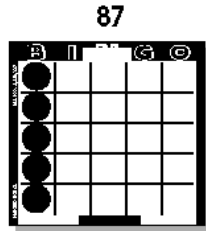

87  
Regular Bingo w/4 Corners  
(13 Combinations)

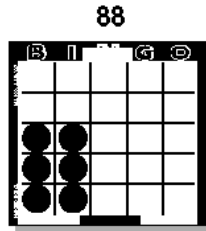

88  
Six Pack (Hard Way)  
(12 Combinations)

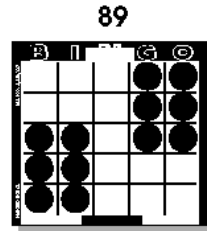

89  
Double Six Pack (Hard Way)  
(18 Combinations)

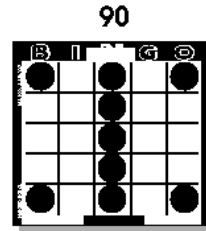

90  
Single Line Plus 4 Corners  
(12 Combinations)

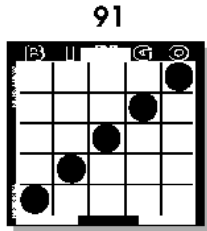

91  
Standard Bingo w/o 4 Corners  
(12 Combinations)

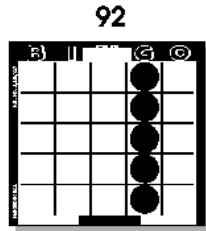

92  
Single Line (Hard Way)  
(8 Combinations)

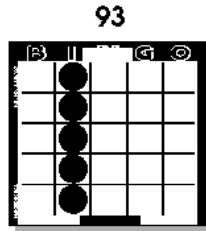

93  
Stand. w/4-Corners Postage Stamp  
(17 Combinations)

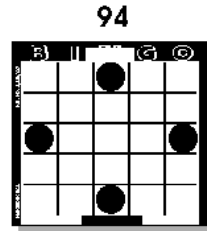

94  
Stand. 1+O 4C, PS, Small Diamond, Tips Lg. Diamond  
(20 Combinations)

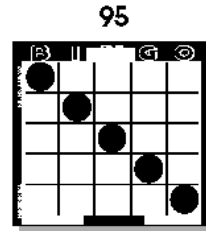

95  
Any Diagonal  
(2 Combinations)

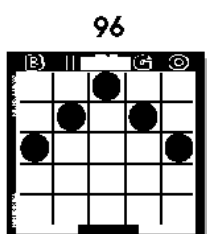

96  
Chevron

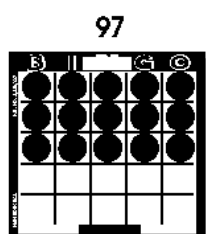

97  
Stack of 3 (1/2 Coverall)  
(2 Combinations)

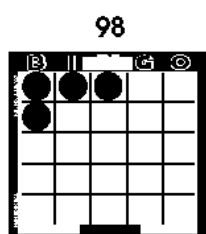

98  
4 Around the Corner  
(13 Combinations)

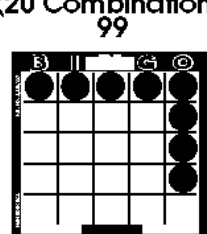

99  
Eight Around the Corner  
(10 Combinations)

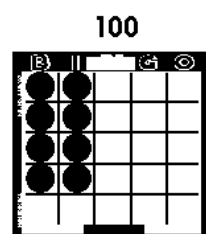

100  
Block of 8  
(16 Combinations)

# Operator's Game Pattern Worksheets

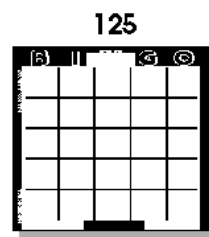
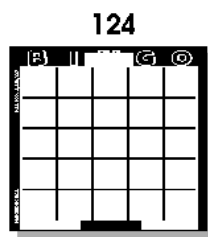
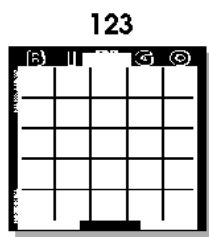
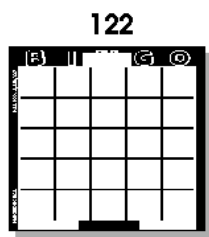
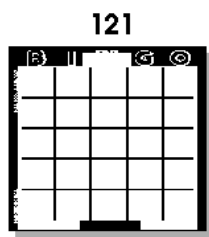
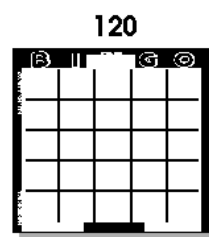
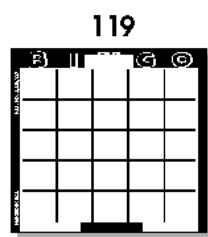
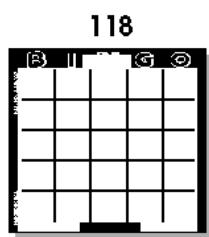
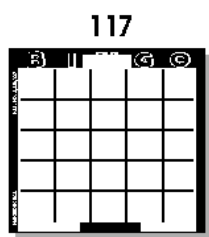
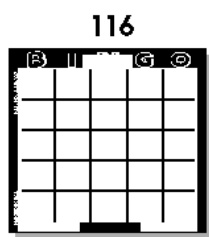
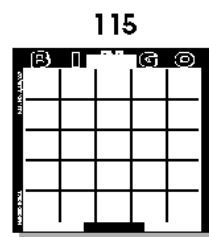
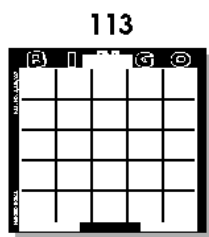
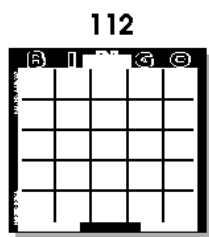
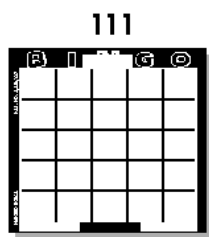
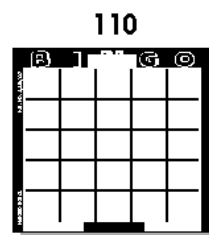
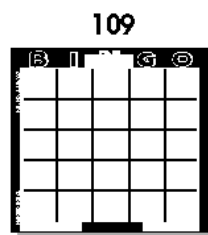
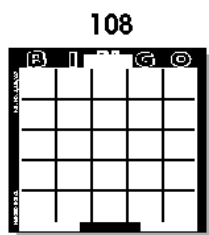
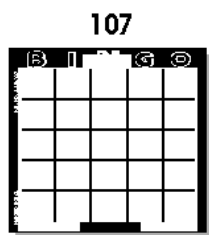
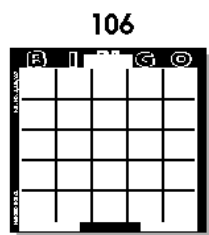
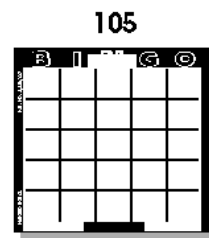
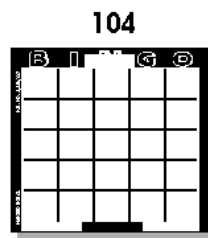
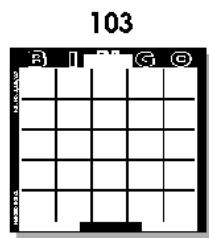
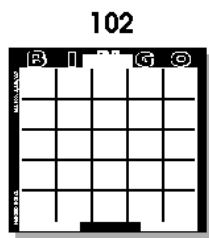
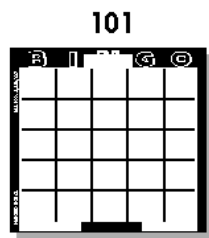

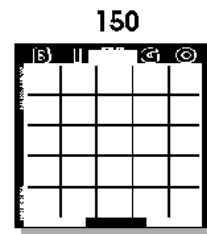
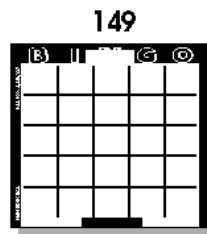
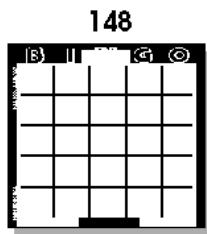
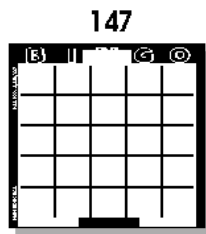
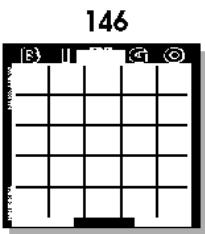
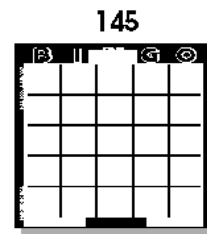
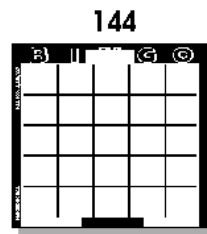
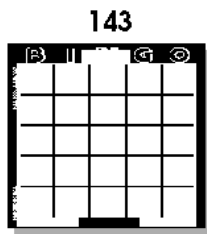
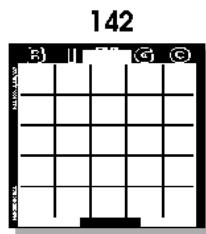
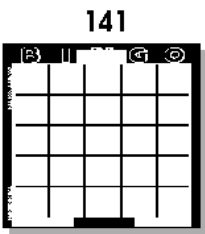
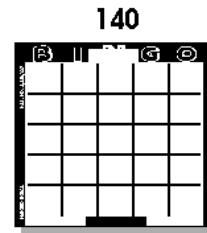
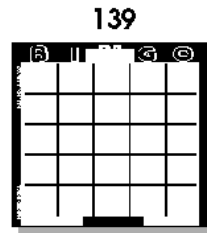
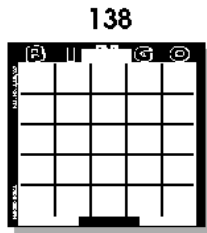
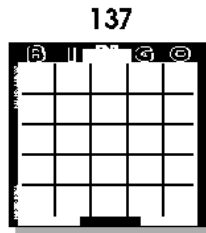
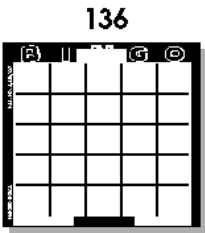
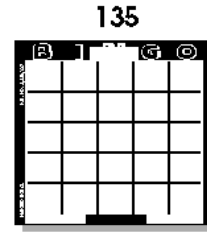
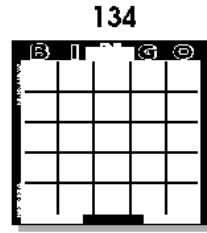
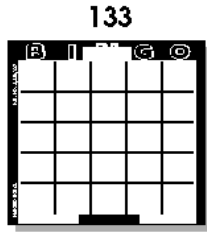
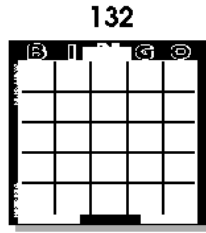
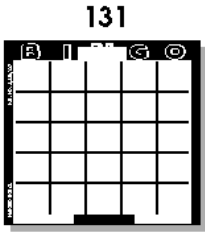
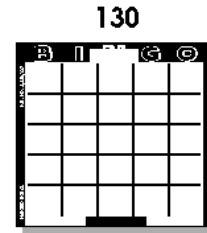
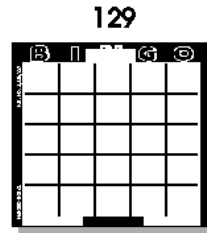
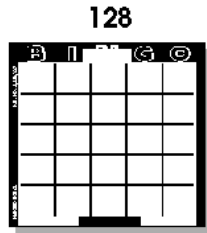
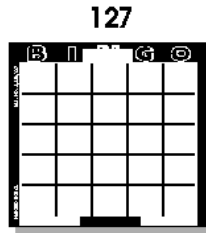
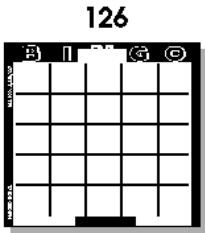



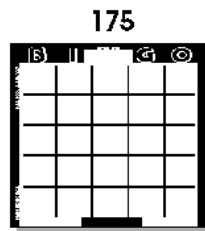
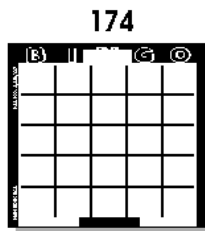
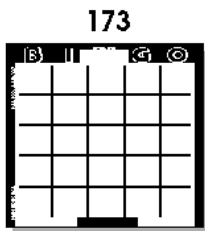
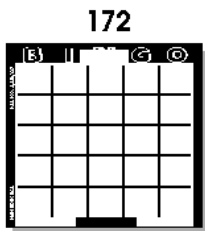
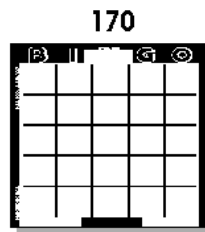
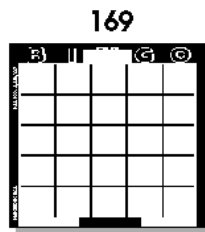
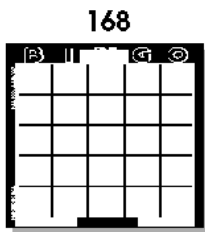
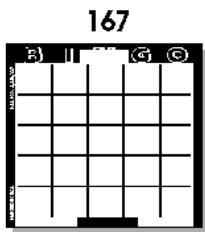
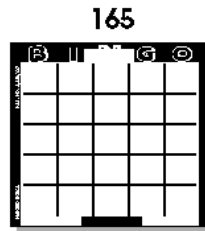
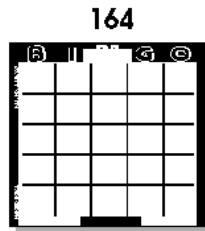
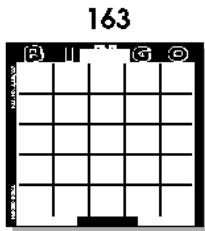
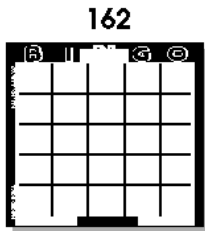
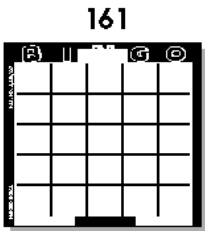
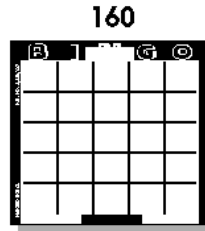
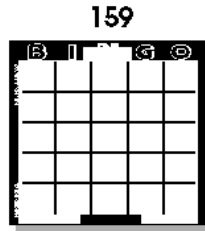
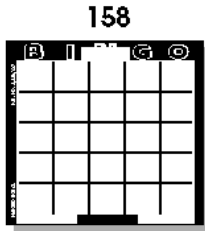
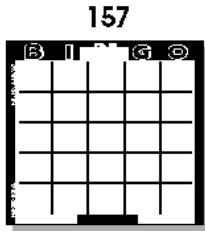
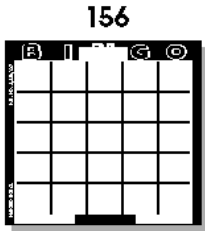
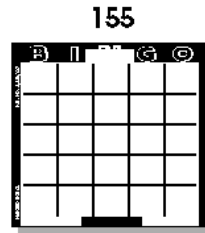
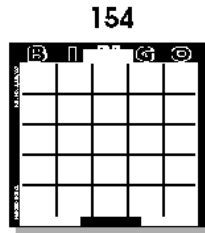
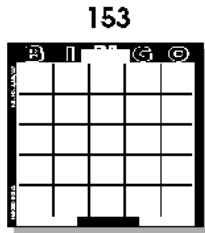
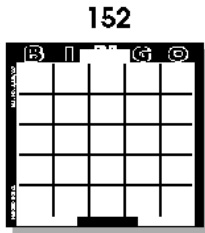
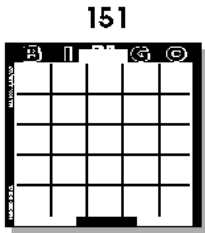

176

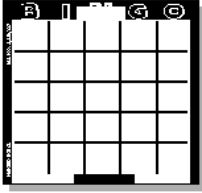

\_\_\_\_\_

177

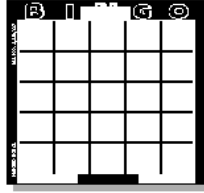

\_\_\_\_\_

178

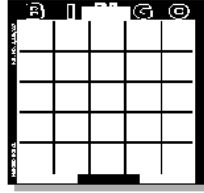

\_\_\_\_\_

179

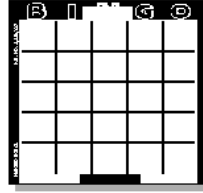

\_\_\_\_\_

180

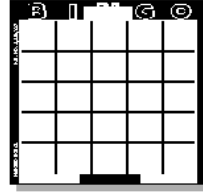

\_\_\_\_\_

181

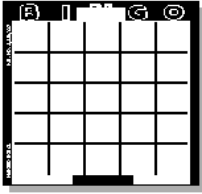

\_\_\_\_\_

182

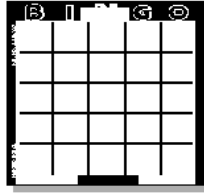

\_\_\_\_\_

183

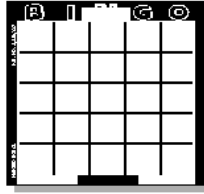

\_\_\_\_\_

184

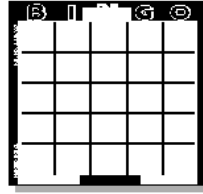

\_\_\_\_\_

185

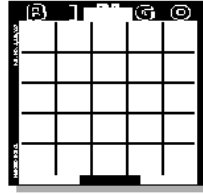

\_\_\_\_\_

186

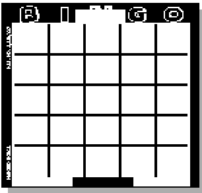

\_\_\_\_\_

187

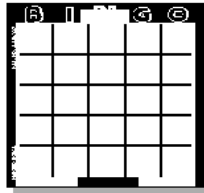

\_\_\_\_\_

188

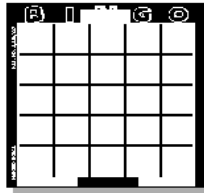

\_\_\_\_\_

189

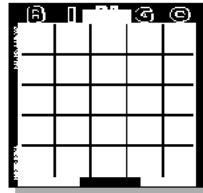

\_\_\_\_\_

190

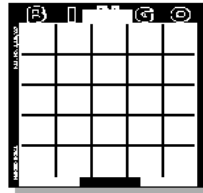

\_\_\_\_\_

191

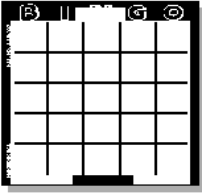

\_\_\_\_\_

192

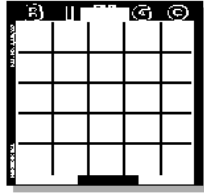

\_\_\_\_\_

193

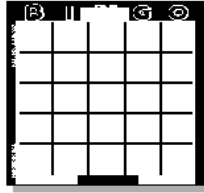

\_\_\_\_\_

194

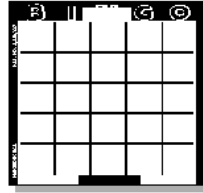

\_\_\_\_\_

195

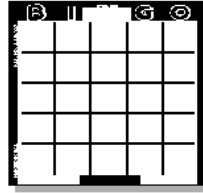

\_\_\_\_\_

196

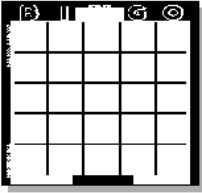

\_\_\_\_\_

197

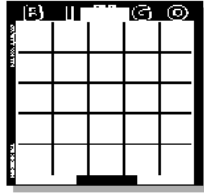

\_\_\_\_\_

198

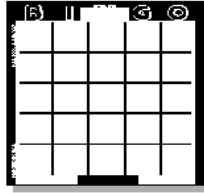

\_\_\_\_\_

199

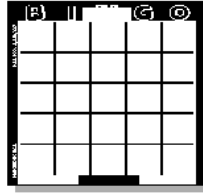

\_\_\_\_\_

200

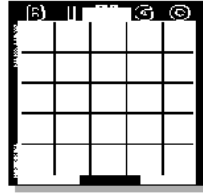

\_\_\_\_\_

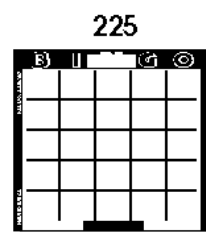
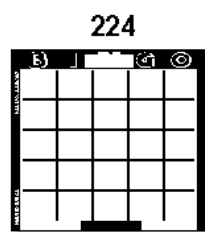
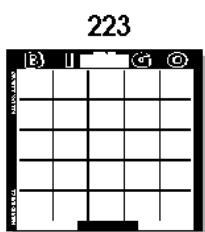
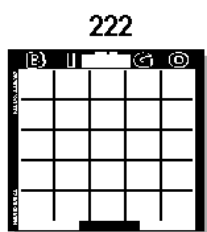
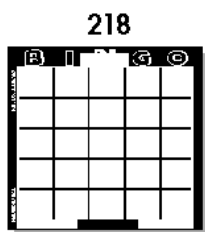
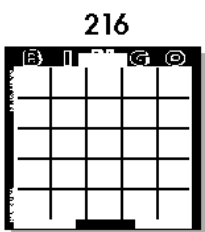
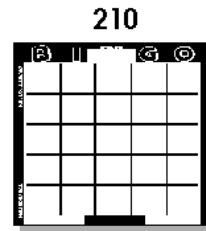
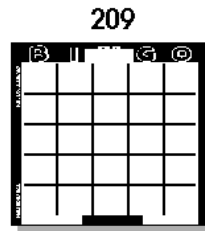
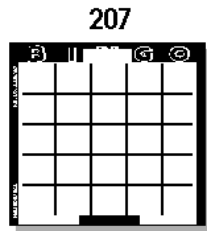
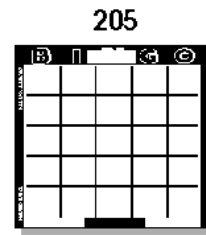
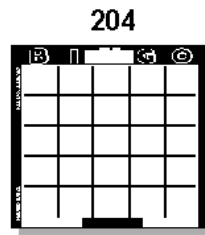

226

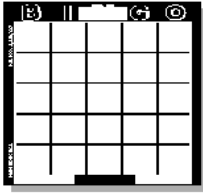

227

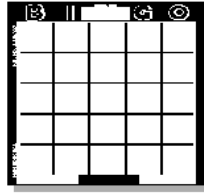

228

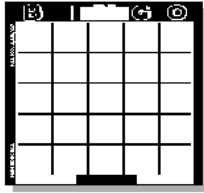

229

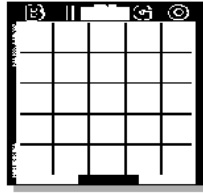

230

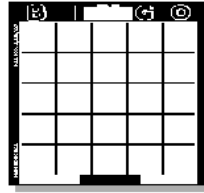

231

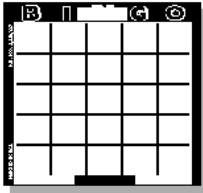

232

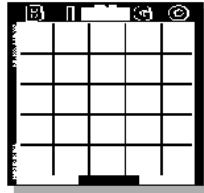

233

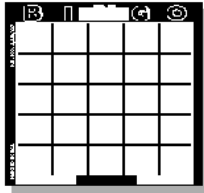

234

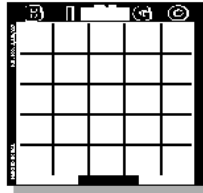

235

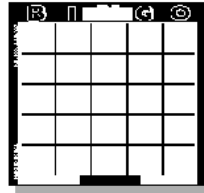

236

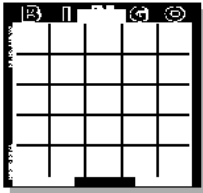

237

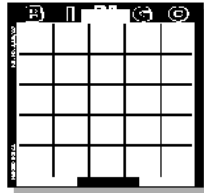

238

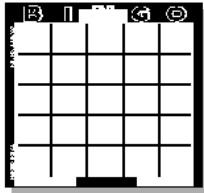

239

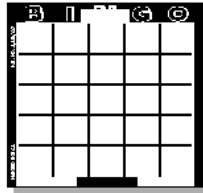

240

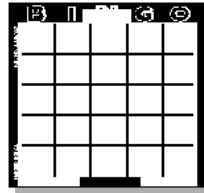

## Session Programming Worksheets

GAME #1	_____	PATTERN	_____	\$ VALUE	_____	BALL TIMER	_____
	_____		_____		_____		_____
	_____		_____		_____		_____
	_____		_____		_____		_____
GAME #2	_____	PATTERN	_____	\$ VALUE	_____	BALL TIMER	_____
	_____		_____		_____		_____
	_____		_____		_____		_____
	_____		_____		_____		_____
GAME #3	_____	PATTERN	_____	\$ VALUE	_____	BALL TIMER	_____
	_____		_____		_____		_____
	_____		_____		_____		_____
	_____		_____		_____		_____
GAME #4	_____	PATTERN	_____	\$ VALUE	_____	BALL TIMER	_____
	_____		_____		_____		_____
	_____		_____		_____		_____
	_____		_____		_____		_____
GAME #5	_____	PATTERN	_____	\$ VALUE	_____	BALL TIMER	_____
	_____		_____		_____		_____
	_____		_____		_____		_____
	_____		_____		_____		_____
GAME #6	_____	PATTERN	_____	\$ VALUE	_____	BALL TIMER	_____
	_____		_____		_____		_____
	_____		_____		_____		_____
	_____		_____		_____		_____
GAME #7	_____	PATTERN	_____	\$ VALUE	_____	BALL TIMER	_____
	_____		_____		_____		_____
	_____		_____		_____		_____
	_____		_____		_____		_____
GAME #8	_____	PATTERN	_____	\$ VALUE	_____	BALL TIMER	_____
	_____		_____		_____		_____
	_____		_____		_____		_____
	_____		_____		_____		_____
GAME #9	_____	PATTERN	_____	\$ VALUE	_____	BALL TIMER	_____
	_____		_____		_____		_____
	_____		_____		_____		_____
	_____		_____		_____		_____
GAME #10	_____	PATTERN	_____	\$ VALUE	_____	BALL TIMER	_____
	_____		_____		_____		_____
	_____		_____		_____		_____
	_____		_____		_____		_____

GAME #11	_____	PATTERN	_____	\$ VALUE	_____	BALL TIMER	_____
	_____		_____		_____		_____
	_____		_____		_____		_____
	_____		_____		_____		_____
GAME #12	_____	PATTERN	_____	\$ VALUE	_____	BALL TIMER	_____
	_____		_____		_____		_____
	_____		_____		_____		_____
	_____		_____		_____		_____
GAME #13	_____	PATTERN	_____	\$ VALUE	_____	BALL TIMER	_____
	_____		_____		_____		_____
	_____		_____		_____		_____
	_____		_____		_____		_____
GAME #14	_____	PATTERN	_____	\$ VALUE	_____	BALL TIMER	_____
	_____		_____		_____		_____
	_____		_____		_____		_____
	_____		_____		_____		_____
GAME #15	_____	PATTERN	_____	\$ VALUE	_____	BALL TIMER	_____
	_____		_____		_____		_____
	_____		_____		_____		_____
	_____		_____		_____		_____
GAME #16	_____	PATTERN	_____	\$ VALUE	_____	BALL TIMER	_____
	_____		_____		_____		_____
	_____		_____		_____		_____
	_____		_____		_____		_____
GAME #17	_____	PATTERN	_____	\$ VALUE	_____	BALL TIMER	_____
	_____		_____		_____		_____
	_____		_____		_____		_____
	_____		_____		_____		_____
GAME #18	_____	PATTERN	_____	\$ VALUE	_____	BALL TIMER	_____
	_____		_____		_____		_____
	_____		_____		_____		_____
	_____		_____		_____		_____
GAME #19	_____	PATTERN	_____	\$ VALUE	_____	BALL TIMER	_____
	_____		_____		_____		_____
	_____		_____		_____		_____
	_____		_____		_____		_____
GAME #20	_____	PATTERN	_____	\$ VALUE	_____	BALL TIMER	_____
	_____		_____		_____		_____
	_____		_____		_____		_____
	_____		_____		_____		_____

GAME #21 \_\_\_\_\_ PATTERN \_\_\_\_\_ \$ VALUE \_\_\_\_\_ BALL TIMER \_\_\_\_\_  
\_\_\_\_\_  
\_\_\_\_\_  
\_\_\_\_\_

GAME #22 \_\_\_\_\_ PATTERN \_\_\_\_\_ \$ VALUE \_\_\_\_\_ BALL TIMER \_\_\_\_\_  
\_\_\_\_\_  
\_\_\_\_\_  
\_\_\_\_\_

GAME #23 \_\_\_\_\_ PATTERN \_\_\_\_\_ \$ VALUE \_\_\_\_\_ BALL TIMER \_\_\_\_\_  
\_\_\_\_\_  
\_\_\_\_\_  
\_\_\_\_\_

GAME #24 \_\_\_\_\_ PATTERN \_\_\_\_\_ \$ VALUE \_\_\_\_\_ BALL TIMER \_\_\_\_\_  
\_\_\_\_\_  
\_\_\_\_\_  
\_\_\_\_\_

GAME #25 \_\_\_\_\_ PATTERN \_\_\_\_\_ \$ VALUE \_\_\_\_\_ BALL TIMER \_\_\_\_\_  
\_\_\_\_\_  
\_\_\_\_\_  
\_\_\_\_\_

GAME #26 \_\_\_\_\_ PATTERN \_\_\_\_\_ \$ VALUE \_\_\_\_\_ BALL TIMER \_\_\_\_\_  
\_\_\_\_\_  
\_\_\_\_\_  
\_\_\_\_\_

GAME #27 \_\_\_\_\_ PATTERN \_\_\_\_\_ \$ VALUE \_\_\_\_\_ BALL TIMER \_\_\_\_\_  
\_\_\_\_\_  
\_\_\_\_\_  
\_\_\_\_\_

GAME #28 \_\_\_\_\_ PATTERN \_\_\_\_\_ \$ VALUE \_\_\_\_\_ BALL TIMER \_\_\_\_\_  
\_\_\_\_\_  
\_\_\_\_\_  
\_\_\_\_\_

GAME #29 \_\_\_\_\_ PATTERN \_\_\_\_\_ \$ VALUE \_\_\_\_\_ BALL TIMER \_\_\_\_\_  
\_\_\_\_\_  
\_\_\_\_\_  
\_\_\_\_\_

GAME #30 \_\_\_\_\_ PATTERN \_\_\_\_\_ \$ VALUE \_\_\_\_\_ BALL TIMER \_\_\_\_\_  
\_\_\_\_\_  
\_\_\_\_\_  
\_\_\_\_\_



GAME #31 \_\_\_\_\_ PATTERN \_\_\_\_\_ \$ VALUE \_\_\_\_\_ BALL TIMER \_\_\_\_\_  
\_\_\_\_\_  
\_\_\_\_\_  
\_\_\_\_\_

GAME #32 \_\_\_\_\_ PATTERN \_\_\_\_\_ \$ VALUE \_\_\_\_\_ BALL TIMER \_\_\_\_\_  
\_\_\_\_\_  
\_\_\_\_\_  
\_\_\_\_\_

GAME #33 \_\_\_\_\_ PATTERN \_\_\_\_\_ \$ VALUE \_\_\_\_\_ BALL TIMER \_\_\_\_\_  
\_\_\_\_\_  
\_\_\_\_\_  
\_\_\_\_\_

GAME #34 \_\_\_\_\_ PATTERN \_\_\_\_\_ \$ VALUE \_\_\_\_\_ BALL TIMER \_\_\_\_\_  
\_\_\_\_\_  
\_\_\_\_\_  
\_\_\_\_\_

GAME #35 \_\_\_\_\_ PATTERN \_\_\_\_\_ \$ VALUE \_\_\_\_\_ BALL TIMER \_\_\_\_\_  
\_\_\_\_\_  
\_\_\_\_\_  
\_\_\_\_\_

GAME #36 \_\_\_\_\_ PATTERN \_\_\_\_\_ \$ VALUE \_\_\_\_\_ BALL TIMER \_\_\_\_\_  
\_\_\_\_\_  
\_\_\_\_\_  
\_\_\_\_\_

GAME #37 \_\_\_\_\_ PATTERN \_\_\_\_\_ \$ VALUE \_\_\_\_\_ BALL TIMER \_\_\_\_\_  
\_\_\_\_\_  
\_\_\_\_\_  
\_\_\_\_\_

GAME #38 \_\_\_\_\_ PATTERN \_\_\_\_\_ \$ VALUE \_\_\_\_\_ BALL TIMER \_\_\_\_\_  
\_\_\_\_\_  
\_\_\_\_\_  
\_\_\_\_\_

GAME #39 \_\_\_\_\_ PATTERN \_\_\_\_\_ \$ VALUE \_\_\_\_\_ BALL TIMER \_\_\_\_\_  
\_\_\_\_\_  
\_\_\_\_\_  
\_\_\_\_\_

GAME #40 \_\_\_\_\_ PATTERN \_\_\_\_\_ \$ VALUE \_\_\_\_\_ BALL TIMER \_\_\_\_\_  
\_\_\_\_\_  
\_\_\_\_\_  
\_\_\_\_\_





GAME #41 \_\_\_\_\_ PATTERN \_\_\_\_\_ \$ VALUE \_\_\_\_\_ BALL TIMER \_\_\_\_\_  
\_\_\_\_\_  
\_\_\_\_\_  
\_\_\_\_\_

GAME #42 \_\_\_\_\_ PATTERN \_\_\_\_\_ \$ VALUE \_\_\_\_\_ BALL TIMER \_\_\_\_\_  
\_\_\_\_\_  
\_\_\_\_\_  
\_\_\_\_\_

GAME #43 \_\_\_\_\_ PATTERN \_\_\_\_\_ \$ VALUE \_\_\_\_\_ BALL TIMER \_\_\_\_\_  
\_\_\_\_\_  
\_\_\_\_\_  
\_\_\_\_\_

GAME #44 \_\_\_\_\_ PATTERN \_\_\_\_\_ \$ VALUE \_\_\_\_\_ BALL TIMER \_\_\_\_\_  
\_\_\_\_\_  
\_\_\_\_\_  
\_\_\_\_\_

GAME #45 \_\_\_\_\_ PATTERN \_\_\_\_\_ \$ VALUE \_\_\_\_\_ BALL TIMER \_\_\_\_\_  
\_\_\_\_\_  
\_\_\_\_\_  
\_\_\_\_\_

GAME #46 \_\_\_\_\_ PATTERN \_\_\_\_\_ \$ VALUE \_\_\_\_\_ BALL TIMER \_\_\_\_\_  
\_\_\_\_\_  
\_\_\_\_\_  
\_\_\_\_\_

GAME #47 \_\_\_\_\_ PATTERN \_\_\_\_\_ \$ VALUE \_\_\_\_\_ BALL TIMER \_\_\_\_\_  
\_\_\_\_\_  
\_\_\_\_\_  
\_\_\_\_\_

GAME #48 \_\_\_\_\_ PATTERN \_\_\_\_\_ \$ VALUE \_\_\_\_\_ BALL TIMER \_\_\_\_\_  
\_\_\_\_\_  
\_\_\_\_\_  
\_\_\_\_\_

GAME #49 \_\_\_\_\_ PATTERN \_\_\_\_\_ \$ VALUE \_\_\_\_\_ BALL TIMER \_\_\_\_\_  
\_\_\_\_\_  
\_\_\_\_\_  
\_\_\_\_\_

GAME #50 \_\_\_\_\_ PATTERN \_\_\_\_\_ \$ VALUE \_\_\_\_\_ BALL TIMER \_\_\_\_\_  
\_\_\_\_\_  
\_\_\_\_\_  
\_\_\_\_\_



# Playing Sessions and Games

Chapter

4

## Playing a Bingo Game

To begin a bingo session, turn on the main console power switch, the blower lamp switch, mixer motor switch and then the blower motor switch on the Sapphire Bingo console. You will notice that balls are immediately blown up the ball tube and held in the ball catcher available for play.

Next, turn on the power switch to all flashboards on the system. The flashboards will go through a self test on the initial power up. By pressing the 'SPECIAL' and 'TEST' keys on the Sapphire Bingo console, all the lights will illuminate to check for any light bulbs out before playing bingo.

The timer will evenly pace your ball calling, adjust the pace of the game and build player confidence to play additional bingo faces with the same payout, thus increasing your revenues. Until you find a time that is most comfortable for you and your players, a good calling time might be every 14 to 20 seconds. When the beeper sounds, it is time to call the next ball.

When you are ready to begin bingo, place the first ball in front of the camera for a few seconds and then call that number and place the ball in the corresponding slot in the ball tray. Remove the next ball from the ball catcher and place it in front of the camera. The caller should never be handling more than one ball at any time. When the timer sounds, call the number of the ball in front of the camera and place it the corresponding slot of the ball tray. Continue this procedure until bingo is called.

At this time verify all the bingos that have been called. It is usually best if the floor worker calls out the serial number of the bingo paper to verify purchase from your hall. Then have the floor worker call out the free space number one digit at a time with the caller entering the number simultaneously into the verifier.

At the end of the game, press the 'NEXT GAME' key. Drop the balls from the tray by pushing both ball release tabs forward fully. The ball gate release knob must be turned counterclockwise to dump the balls back into the ball mixing chamber. The gate acts as a security barrier in order to prevent the balls from reentering the ball mixing chamber. Air in the mixing chamber can occasionally prevent the balls from dumping normally. If this happens, briefly turn off the blower motor switch, allow the balls to drop, and turn the blower motor switch back on.

Be sure to visually check the ball return tray and chute to verify that all balls have been returned to the ball mixing chamber. Do not forget the ball in front of the camera. Press the 'ENTER' key and you are ready for the next game.

At the end of the session, exit the session (if you are running a programmed session) and simply turn off all power switches.

## Manual Games

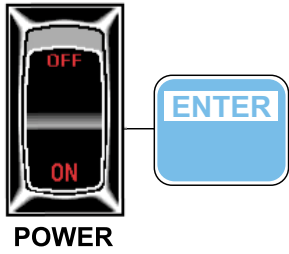

1. Turn the 'POWER' switch on.
2. Press the 'ENTER' key.

The display will read →

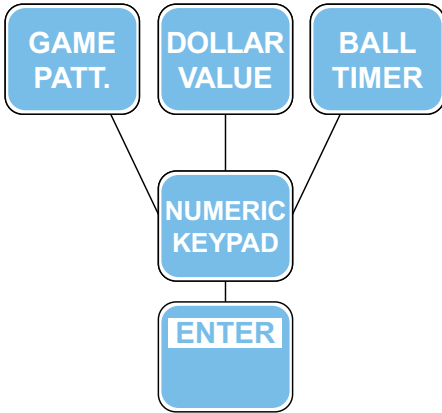
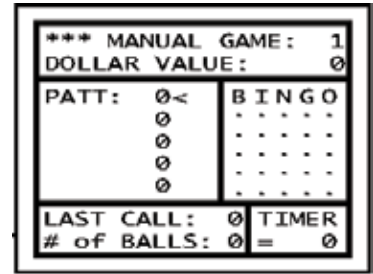

You may now enter the data for the game patterns, dollar value, and the ball timer via the numeric keypad.

3. To enter any data, press the 'GAME PATT.', 'DOLLAR VALUE', or 'BALL TIMER' key and select the desired value by using the numeric keypad.
4. Complete each section by pressing the 'ENTER' key.

## Preprogrammed Session

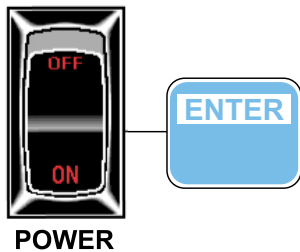

1. Turn on the 'POWER' switch.
2. Press the 'RUN PROG.' key.

The display will read →

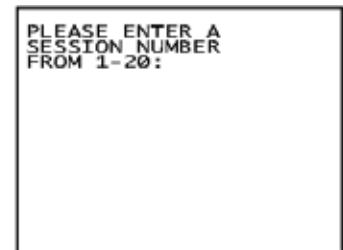

3. Enter the session number using the numeric keypad.
4. Press the 'ENTER' key.

The display will read →

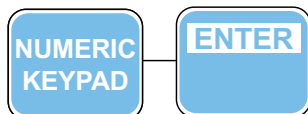
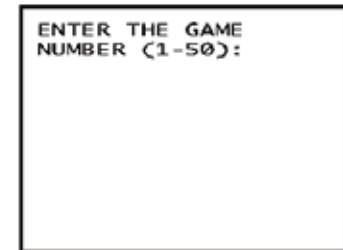

5. Enter the game number using the numeric keypad.
6. Press the 'ENTER' key.

The display will read →

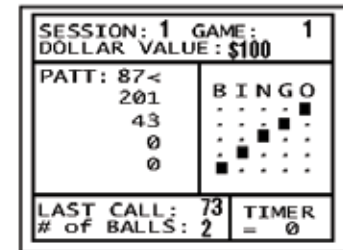

(The numbers shown are examples)

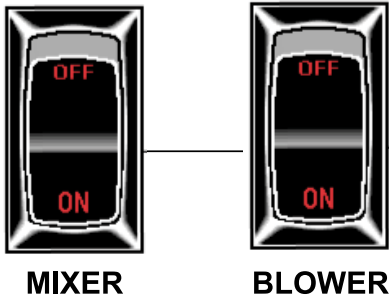

7. Turn on the 'MIXER' switch.
8. Turn on the 'BLOWER' switch.
9. Begin to play BINGO!
10. Upon completion and verification of the first game pattern, use the 'NEXT PATT.' key to move the cursor to the next pattern if this is a progressive game.

The display will read →

SESSION: 1		GAME: 1	
DOLLAR VALUE: \$100			
PATT: 87		B I N G O	
201 <		■	■
43		■	■
0		■	■
0		■	■
LAST CALL: 73		TIMER	
# of BALLS: 2		= 0	

**NOTE:**

If the 'NEXT PATT.' is pressed too many times, continue pressing the 'NEXT PATT.' key until the cursor corresponds with the desired game pattern.

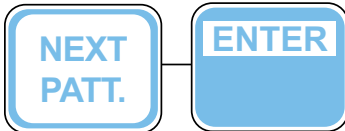

Otherwise, press 'NEXT GAME' key followed by 'ENTER' to go to the next game.

PLEASE CLEAR THE BALL TRAY NOW--  
AND OPEN BALL GATE  
  
PUSH 'ENTER' TO CONTINUE...  
OR 'CANCEL' TO EXIT



11. To exit the session, press the 'SPECIAL' key followed by the 'EXIT' key. To confirm the session exit, press 'ENTER'.

PRESS 'ENTER' TO CANCEL THE SESSION  
OR ANY OTHER KEY TO RESUME THE GAME

## Changing Preprogrammed Game Data

To temporarily change the preprogrammed game data:

1. To enter a new game pattern, press the 'GAME PATT.' key.
2. Enter the new game pattern number using the numeric keypad.
3. Press the 'ENTER' key. The screen will display the new game pattern.

The same may be done for the ball timer and dollar value amounts.

4. Begin or resume play of the game.

To permanently change the game, follow the "PROGRAMMING A SESSION" instructions on page 22. When entering into the edit mode, use the numeric keypad to select the SESSION and then the GAME NUMBER you would like to edit.

## Canceling a Ball



If a ball has been inserted in to the wrong numbered slot:

1. Remove the ball from the incorrect position.
2. Press the 'CANCEL' key. The display will read

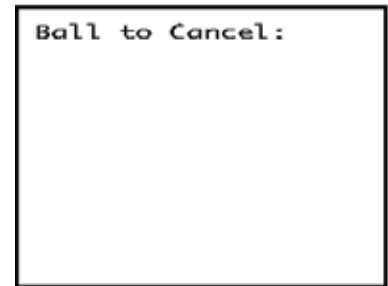

3. Type in the number of the ball to cancel using the numeric keypad.

4. Press the 'ENTER' key.



5. Insert the ball into its correct spot.

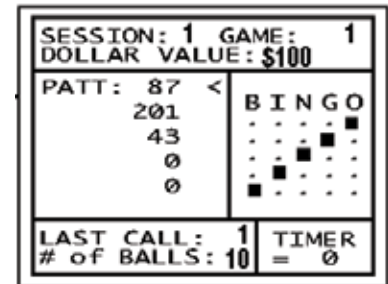

### NOTE:

The incorrect number will disappear from the flashboard and the console display, and the balls called will decrement by one.

## Verifying a Bingo

1. Press the 'VERIFY' key.

VERIFY OPTIONS:  
SPEC = SELECT PAPER  
W = WIN TALLEY  
S = ERASE WIN PATTS  
CANCEL = RETURN

CHAMPION SEARCH  
FACE NUMBER:

2. If you are verifying a standard Champion paper series, proceed to step #4. Otherwise, press the 'SPECIAL' key followed by the number corresponding to the type of bingo paper series that you would like to verify using the numeric keypad. You will be returned to the VERIFY screen after selection. If a different default paper is wanted, press the "D" plus the number of the paper you wish to have.

### NOTE:

Pressing D does not show anything on the screen. After selecting the type of paper, the VERIFY screen will show your paper selection..

### NOTE:

All series types on the screen below are included in the AUTO SEARCH except Double Action and the SPEC Paper.

Pressing SPECIAL shows you:

ENTER SERIES TYPE  
DEFAULT WILL CLEAR

1. CHAMPION
2. GIANT #
3. MARK 75
4. RELIABLE
5. SHUTTER CARDS
6. DOUBLE ACTION

SPEC = SELECT OTHER PAPER

D PLUS # TO SET DEFAULT  
S TO SET AUTO SEARCH

3. If you would like to select other paper types, select SPECIAL again followed by the number corresponding to the type of bingo paper series that you would like to verify using the numeric keypad. You will be returned to the VERIFY screen.

**NOTE:**

You can also set the default paper from this screen.

Pressing SPECIAL again shows you:

ENTER SERIES TYPE  
DEFAULT WILL CLEAR

1. CAPITOL - UNIMAX
2. DAB ALL 75
3. MINI 75
4. JACKPOT
5. DUAL DAB

D PLUS # TO SET DEFAULT

PRESS ANY OTHER KEY TO EXIT.

**CAUTION:**

None of these OTHER series of papers are included in any type of AUTO SEARCH.

4. Enter the free-space number from the bingo card face of the person who called BINGO using the numeric keypad and then press 'ENTER'.
5. Press the 'ENTER' key again if you wish to verify other bingos called in that game and repeat step #4.
6. Press the "W" key to calculate the payout to each winner, followed by the 'ENTER' key.
7. To exit the verify mode, press the 'ENTER' key followed by the 'CANCEL' key.
8. See page 45 for information regarding deleting a winning pattern.

**NOTE:**

To set the verifier to AUTO SEARCH, press the 'SPECIAL' key for the paper selection screen and then press the "S" key to set mode to AUTO SEARCH. Press the 'NEXT PATTERN' button to scroll through available AUTO SEARCHed patterns.

# Special Functions

## Chapter

# 5

### Testing the System

1. Press the 'SPECIAL' key.
2. Press the 'TEST' key. All flashboards' lights will illuminate.
3. Press the 'ENTER' key to leave the test mode.

### Entering a Wild Number

1. Press the 'SPECIAL' key.
2. Press the 'WILD' key.
3. Wild number options:
  - a. Enter any 2-digit number for a single wild number.  
Enter as many wild numbers as you desire while pressing the 'ENTER' key after each entry.
  - b. Use "W" before a single digit to call all balls ending in that digit.  
For example: W3 would give 3, 13, 23, 33, . . . . . 73
  - c. Use "W" after a single digit to call all double-digit ball numbers beginning with that digit.  
For example: 3W would give 30, 31, 32, 33, . . . . . 39
  - d. Use "D" to call all odd numbers.
  - e. Use "S" to call all even numbers.
4. When finished, press the 'SPECIAL' key followed by the 'EXIT' key to exit the wild number mode.

#### NOTE:

Another way to enter a wild number is to simply use your finger to press the desired ball tray switch until the "BEEP" is heard.

#### NOTE:

The wild number feature could be used to temporarily override a defective ball tray switch.



## **Bonanza Save and Recall**

After calling a specified number of balls (typically 40 - 45):

1. Press the 'SPECIAL' key followed by the 'SAVE' key.
2. The game is now saved. Press the 'ENTER' key to continue.
3. Press the 'NEXT GAME' key to continue playing your session.

To recall the saved game:

1. Press the 'SPECIAL' key followed by the 'RECALL' key.
2. Press the 'ENTER' key to resume play of your saved game.

### **CAUTION:**

If you wish to save this game again to return to it later it must be RESAVED! This is even if you do not call any balls. Once recalled, it is removed from memory. Just follow steps 1 - 3 above to save the game.

## **Delete Winning Pattern**

A multiple face pattern can be played and when one of the faces wins, it can be deleted from the rotation. This allows for all the patterns in the rotation to BINGO in the same game but not necessarily at the same time.

1. After verifying a valid bingo, press the 'ENTER' key to return to the options screen.
2. Press the "S" key.
3. Repeat steps 1 and 2 until all bingos have been verified and winning patterns deleted.

## **Game Recall (Resume Previous Game)**

This feature allows (in Auto mode only) an operator to recall the previous game with all game parameters and balls called.

### **CAUTION:**

This option can only be used BEFORE the first ball called. If a ball has been called, you CANNOT return to the previous game!

For example, if the operator accidentally presses 'NEXT GAME' followed by the 'ENTER' key, the caller can recover and RECALL or RESTART the game he left. (Again, only if a ball has NOT been called in the new game.)

To recall the saved game:

1. Press the 'SPECIAL' key.
2. Press the 'RESUME' key.
3. Resume playing the game.

### Speed Bingo

This option is used to run a game (in manual mode only) several times in succession with little effort. Set your ball timer, game pattern, and dollar values as described on page 39 explaining manual game setup. When using this option, the game number will increment, but the ball timer, game pattern, and dollar values will not change.

1. Empty the ball tray.
2. Press the 'SPECIAL' key.
3. Press the 'RESUME' key.

### Printer Option

*Printer needs to be installed to have functionality.*

Use a standard dot matrix line feed Epson emulated printer with an IBM compatible parallel printer cable. Connect the cable into both the printer and the console printer interface connectors. Make sure the printer is powered on and online with an ample amount of paper.

Once game play begins, the printer will begin to print a running *audit trail* of vital game statistics:

<b>Sapphire Bingo Console by Bingo King</b>											
<b>Session: 3 Game: 6 Time: 8:21 Date: 7-1-93</b>											
ROT	BALL	TIME	ROT	BALL	TIME	ROT	BALL	TIME	ROT	BALL	TIME
1	#62	8:21	2	#22	8:21	3	#3	8:21	4	#16	8:22
5	#57	8:22	6	#27	8:22	7	#12	8:23	8	#75	8:23
9	#40	8:23	10	#9	8:24	11	#72	8:24	12	#11	8:24
13	#29	8:25	14	#73	8:25	15	#48	8:25	16	#31	8:26
17	#38	8:26	18	#46	8:26	19	#13	8:27	20	#70	8:27
21	#49	8:27	22	#26	8:28	23	#53	8:28	24	#47	8:28
<b>VERIFY</b>			<b>8:29</b>			<b>Face:45000</b>			<b>WINNER</b>		
<b>B I N G O</b>						<b>PATTERN</b>					
3	16	42	46	70	■■■■■■■■						
13	26	31	57	75	■■■■■■■■						
11	29		53	73	■■■■■■■■						
12	22	40	47	62	●●●●●●						
9	27	38	49	72	■■■■■■■■						



Once the game and/or session has ended, a ball frequency report can be generated.

**CAUTION:**

The ball frequency report is valid only for the duration that the machine is on. It can only be run if the console has not been turned off. Once power is turned off, the ball frequency buffer is cleared and cannot be recovered.

If running in manual mode, proceed to step 2, otherwise:

1. Press the 'SPECIAL' key followed by the 'EXIT' key and press 'ENTER'. This will exit you out of the current running session and place you in a manual game mode.
2. Press the 'SPECIAL' key followed by the 'PRINTER' key.

**NOTE:**

Make sure the printer is powered on, is online, and has an ample amount of paper.

The console will read:

**PRINTING BALL TRAY  
ACTIVITY REPORT**

The printer will print:

```
*****SUMMARY OF BALL TRAY ACTIVITY*****  
BALL COUNT BALL COUNT BALL COUNT BALL COUNT BALL COUNT  
# 1 14 # 2 21 # 3 8 # 4 6 # 5 22  
# 6 8 # 7 15 # 8 6 # 9 6 #10 13  
#11 12 #12 7 #13 4 #14 9 #15 6  
#16 3 #17 16 #18 9 #19 14 #20 14  
#21 7 #22 7 #23 16 #24 20 #25 18  
#26 17 #27 4 #28 21 #29 4 #30 20  
#31 6 #32 11 #33 13 #34 17 #35 7  
#36 14 #37 8 #38 5 #39 11 #40 11  
#41 9 #42 15 #43 11 #44 10 #45 9  
#46 6 #47 15 #48 9 #49 7 #50 17  
#51 10 #52 14 #53 23 #54 9 #55 17  
#56 12 #57 5 #58 13 #59 4 #60 12  
#61 13 #62 9 #63 8 #64 16 #65 4  
#66 11 #67 5 #68 10 #69 15 #70 9  
#71 8 #72 11 #73 16 #74 8 #75 21
```



## Time and Date Programming

This option is only useful only when running the optional printer. The time and date are used in printing of the game data.

### Programming the Date

1. If not in MANUAL mode, press the 'SPECIAL' key followed by the 'ENTER' key.
2. Press the 'SPECIAL' key.
3. Press the 'CLOCK' key.
4. Press the "D" key and the system will prompt you for the month, day, and year.
5. Use the numeric keypad to enter in the information, pressing 'ENTER' after each entry.

### CAUTION:

Make sure to always enter in a two digit number.

Example: For 1, enter "0" and "1" and press 'ENTER'.

This is for entering in TIME and DATE information.

### Programming the Time

1. Press the 'SPECIAL' key.
2. Press the 'CLOCK' key.
3. Press the 'ENTER' key for time and the system will prompt you for the hour (24 hour military time) and the minute.
4. Use the numeric keypad to enter in the information, pressing 'ENTER' after each entry.

## Changing Ball Timer Mode

There are two modes of operation available: constant and ball-activated.

### Constant Timer Mode

1. Press the 'SPECIAL' key.
2. Press the 'AUTO' key.
3. Your display will read:

CONSTANT TIMER MODE  
SELECTED - PRESS ANY  
KEY TO RETURN

### Ball-Activated Mode

1. Press the 'SPECIAL' key.
2. Press the 'AUTO' key.
3. Your display will read:

BALL ACTIVATED MODE  
SELECTED - PRESS ANY  
KEY TO RETURN

## **Random Number Generator (Auto Call or Manual Mode)**

This is an optional feature and must be requested/installed prior to shipping out a new console.

When this mode is selected, the on-board computer will randomly choose a user selected number of balls. There are two modes of operation: Automatic calling or manual calling of balls.

### **Auto Call Operation**

1. Press the 'SPECIAL' key.
2. Press the 'RNG' key.
3. Enter the total number of balls you would like to auto call (between 1 and 75).
4. Press the 'ENTER' key. The system will now randomly call the number of balls you have chosen. The speed at which they are called is determined by the ball timer.
5. Press the "S" key to shut off the auto call mode. To restart, begin back at step 1.

### **Manual Mode Operation**

1. Press the 'SPECIAL' key.
2. Press the 'RNG' key.
3. Press the 'ENTER' key.
4. Now you just have to press the "W" key (in the middle of the game pattern keys) to activate a random number. Pace yourself by your ball timer or just press the "W" whenever you'd like to have a random ball displayed.

# Customer Servicing

Chapter

6

## Cleaning

### CAUTION:

Turn off and unplug your console and/or flashboard before performing any maintenance. Failing to perform this very important step could lead to equipment damage and/or personal injury!

### Console Laminated and Painted Surfaces:

Use a soft cloth and mild soap solution to wipe away any dust and dirt that may accumulate. Harsh solvents or cleansers may damage paint, the laminate, or console lettering.

### Console and Flashboard Acrylic Surfaces:

Use only a mild soap solution and a soft cloth. Do not use an ammonia based cleaning agent as this will dull and etch the acrylic surface.

### CAUTION:

Many flashboard manufacturers paint the flashboard acrylic on the outside. Using harsh chemicals and abrasive cloths can remove the paint and damage the look and operation of the flashboard.

### Bingo Balls:

Clean with a mild soap solution. Harsh solvents or cleansers may damage and/or warp your quality bingo balls. Make sure to allow the balls to dry thoroughly.

### CAUTION:

Do NOT use hot water to wash your bingo balls. If the balls are in hot water for just a short time, they can pop open. The air inside the ball will expand beyond the capacity of the ball and the ball will split open, ruining the ball.

### NOTE:

If your bingo balls do not seem to be moving freely after cleaning, make sure they are completely dry and place them in a large paper bag with a very LIGHT coating of talcum powder and shake vigorously. This will allow them to move more freely and help prevent static build-up.

## Static Treatment

Lightly spray “Plastic Safe” anti-static aerosol compound over the blower base pan foam and inside the blower chamber windows to eliminate static. Use sparingly and only when needed. Also check to make sure your static tinsel is still intact. If worn or torn, call your distributor for service and/or parts.

### CAUTION:

Do not spray the ball tube with anti-static spray. This may damage the ball tube even if it is “Plastic Safe” anti-static spray.

## Changing Light Bulbs

### Mixing Chamber Light Bulb

1. Unlock and open the right hand blower compartment door.
2. Remove the acrylic panel covering the lamp by turning the two plastic retaining tabs 180° for clearance.
3. Unscrew the light bulb counter-clockwise to remove it.
4. Insert a new 7-1/2 S clear 120 volt lamp and turn it clockwise until it is snug. Do not overtighten!
5. Replace the acrylic cover and lock it back into its original position with the two locking tabs.
6. Close and lock the blower compartment door.

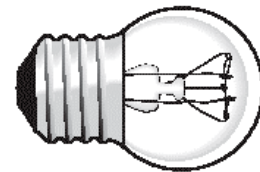
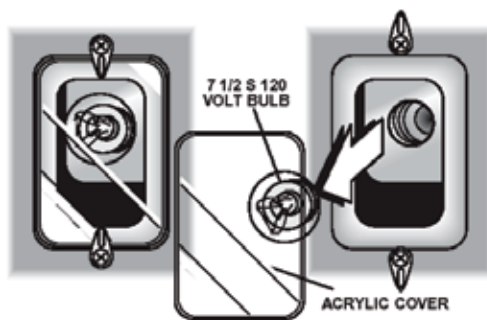

7 1/2 S 120 VOLT LIGHT BULB



**CAUTION:**

Turn off and unplug your console and/or flashboard before performing any maintenance. Failing to perform this very important step could lead to equipment damage and/or personal injury!

**Accessing 4" Flashboard Lamps**

1. Remove the retaining strip next to the vertical bingo lamps. This is accomplished by gently pushing in the low side acrylic panel while grasping the retaining strip and gently pulling it out and to the right. (Refer to drawing B.) Once the strip is removed, slide the acrylic panels to gain access to the light bulbs needing replaced. (Refer to drawing C).
2. Change the light bulb(s) as necessary (Refer to Flashboard Light Bulb section, page 55).
3. Slide the acrylic panels to their home position.
4. Reinsert the retaining strip.

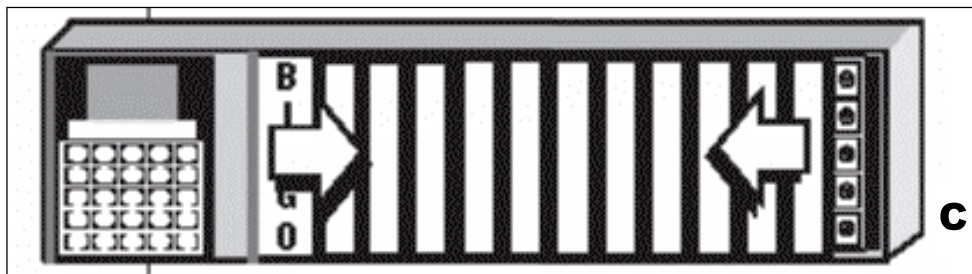
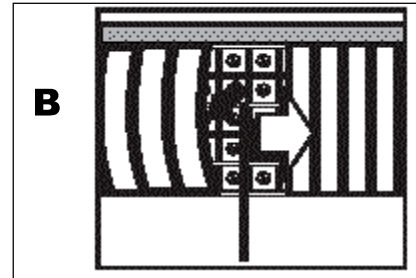

**NOTE:**

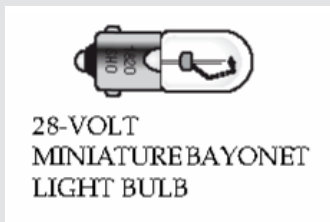

The 1820 miniature bayonet lamp is standard on most manufacturers' flashboards. (Check individual flashboard specifications.) A good lamp should have a resistance measurement of about 28 ohms. Inexpensive lamps often have a poor quality and do not have consistent resistance ratings. Using a lamp that is too far out of specifications could produce too much heat and draw too much current causing premature failure and possible damage to your flashboard electronics and/or plexiglass.

## Accessing 8" Flashboard Lamps

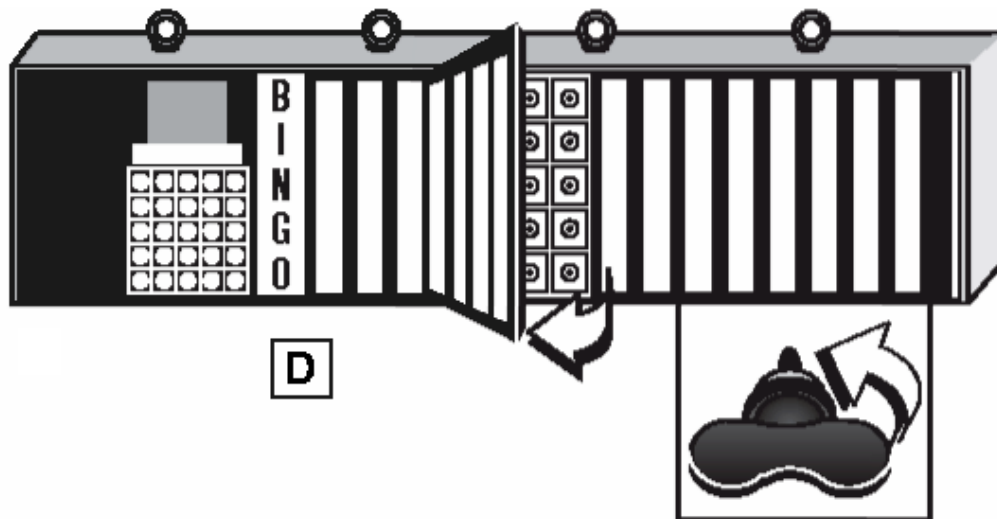

1. Open individual acrylic panels by locating the two 1/4 turn fasteners for each panel and twisting each a 1/4 turn counter-clockwise while gently pushing in.

### **NOTE:**

Power Pack/Game Indicator sections require the use of a Phillips screwdriver.

2. Gently open the acrylic panels allowing the Velcro tabs to release.
3. Change the light bulb(s) as necessary. (Refer to Flashboard Light Bulbs page 55).
4. Close the acrylic panels and apply gentle pressure to lock the Velcro tabs.
5. Lock the acrylic panels in place by gently pushing in the 1/4 turn fastener, compressing the spring and twisting 1/4 turn clockwise.

## Changing Flashboard Light Bulbs

### CAUTION:

Turn off and unplug your console and/or flashboard before performing any maintenance. Failing to perform this very important step could lead to equipment damage and/or personal injury!

1. Gently push light bulb in while turning counterclockwise. Socket is spring loaded and only requires a 1/4 turn to release the light bulb from the socket.
2. Remove the light bulb from the socket.
3. Insert the new light bulb by aligning light bulb pins with the light socket notches and gently pushing in and turning clockwise. Twist 1/4 turn to secure the light bulb in place.
4. Additional light bulbs may be purchased from your distributor or a local electrical or electronics supply house. We recommend using only high quality replacement light bulbs for extended life and to minimize the chance of printed circuit board failures

### NOTE:

The 1820 miniature bayonet lamp is standard on most manufacturers' flashboards. (Check individual flashboard specifications) A good lamp should have a resistance measurement of about 28 ohms. Poor quality lamps often do not have a consistent resistance rating. Using a lamp that is out of specifications could produce too much heat and draw too much current causing premature failure and possible damage to your flashboard electronics and/or plexiglass.

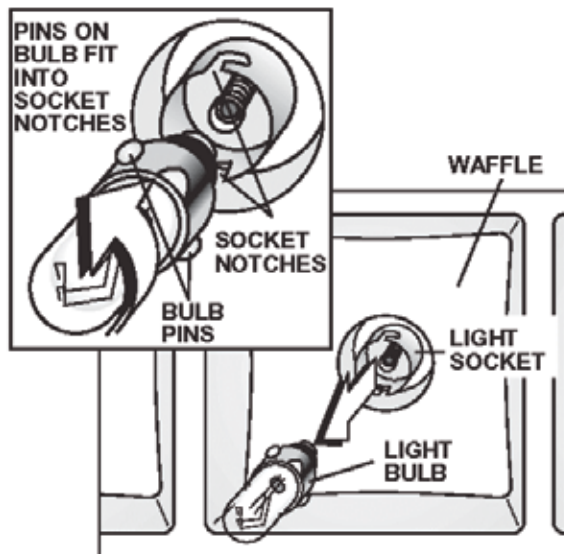

28-VOLT  
MINIATURE BAYONET  
LIGHT BULB

## Blower and Mixer Maintenance

The blower and mixer motor should be serviced every four months or every 200 operating hours.

### CAUTION:

Turn off and unplug your console and/or flashboard before performing any maintenance. Failing to perform this very important step could lead to equipment damage and/or personal injury!

1. Unplug the console power cord from the wall outlet.
2. Unlock and open the right-hand-side blower compartment door. Remove any balls that may be on the blower base pan assembly.
3. Disconnect the power plug located below the blower base pan, remove the one screw on the base pan, and pull the assembly out of the console.
4. Lay the removed blower base pan assembly upside down on a flat surface, remove the four Phillips screws (two from each side) from the protective guard, and lay the protective guard on its side.
5. Put a few drops of 20W oil into the two oiling ports located on the top side at each end of the blower motor. (Refer to illustration.)
6. Oil the mixer motor by removing the two 1/4" bolts from the rear plate of the mixer motor. Oil the felt pad with 20W oil, replace plate and reinsert the bolts, being careful not to over tighten them.
7. Check the blower motor squirrel cage blades for debris. If dirty, loosen the cage from the shaft with a 1/8" Allen wrench and remove from the shaft. Clean the blades with a small stiff brush, using soap and water, and towel dry. Reinstall the squirrel cage and check that the blades are free wheeling and not binding.
9. Reassemble and carefully slide the base pan back into the console with the mixer arm pointing towards the front of the console.
10. Inspect the air filter and replace if necessary.
11. Make sure to reconnect the four-pin power plug.  
Reinsert bingo balls onto blower base pan assembly, close and lock blower compartment door.

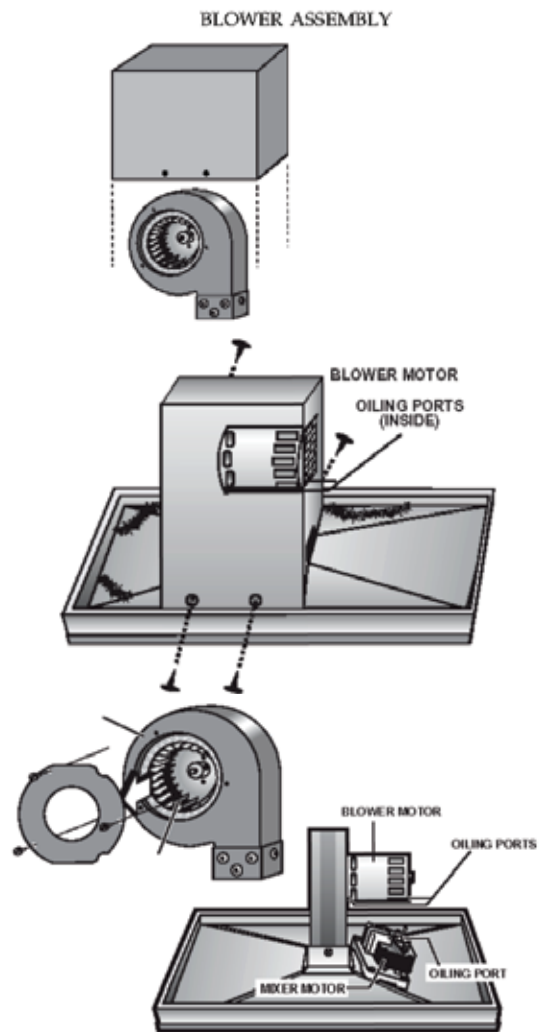

## Console Air Filter Replacement

### NOTE:

The console air filter should be checked regularly. A clogged air filter can cause the balls to have poor ball chamber action and possibly not allow them to push up the ball tube.



Ball chamber door:  
Open door and filter  
is in the bottom of the  
compartment.

1. Turn off power and unplug the console.
2. Unlock and open the ball chamber door.
3. Locate the air filter in the bottom of the blower chamber located under the blower base pan.
4. Rotate the plastic locking tabs out of the way and remove the air filter.
5. Replace with a clean air filter obtained through your Sapphire Console distributor.

## Resetting the Console Circuit Breakers

There are two circuit breakers on your Sapphire Bingo Console: a 6 amp and a 0.1 amp. The 6 amp breaker is for the blower, mixer and lights, while the 0.1 amp breaker handles the circuit board power. Gently press the breaker button in to reset.

### CAUTION:

Do not attempt to reset the breakers without turning off all power and unplugging the console. Failure to do so could expose you to dangerous electrical current.

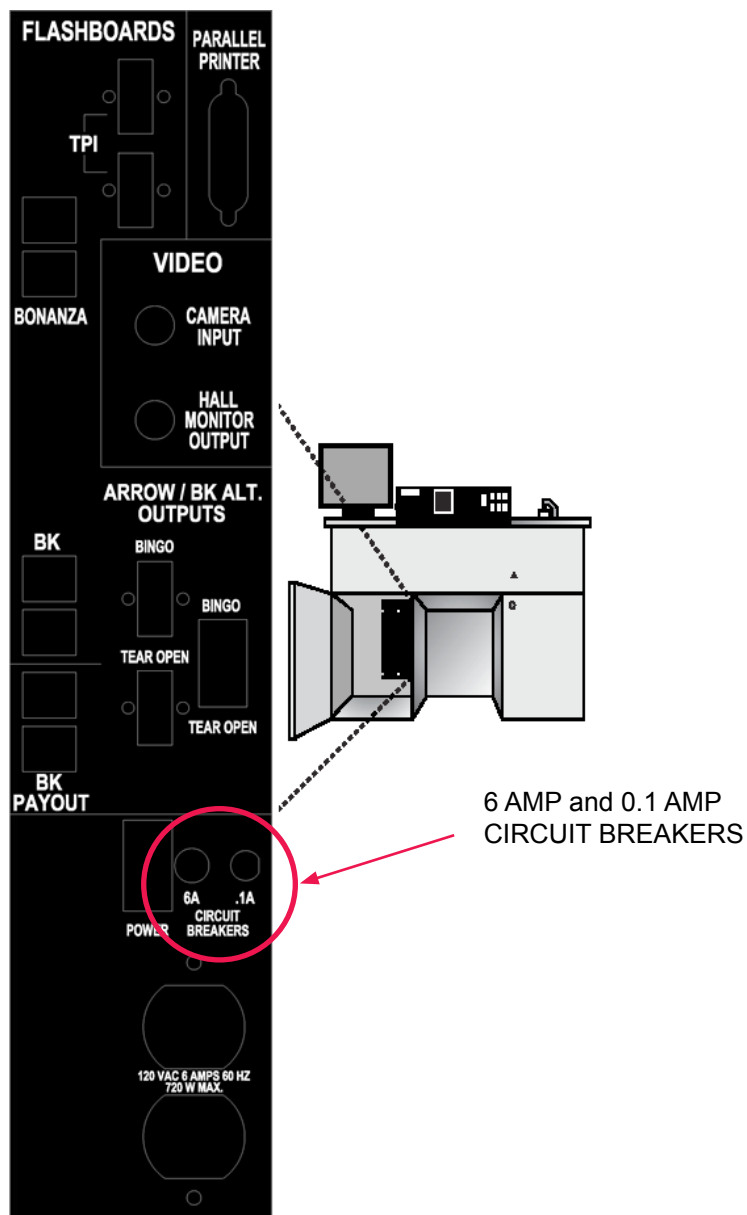

# Troubleshooting

## Chapter

# 7

Before attempting any of the following troubleshooting steps, make sure your console and/or flashboard are plugged into a stable power outlet. The outlet should provide at least 108 VAC. If the voltage is too low, your bingo equipment will not function correctly. The troubleshooting guide assumes the power connections have already been checked and are working.

### NOTE:

When troubleshooting your bingo system, please take note where and when the problems are occurring. If a problem is only present in one flashboard out of many, then the problem is not likely to be in the console, but rather in the flashboard. On the other hand, if the problems are on all flashboards in your hall then it is very likely the problems are associated with the console.

## Blower Motor Troubleshooting

### Blower stopped working:

- Check to make sure the console is plugged in and the outlet voltage is sufficient.
- Make sure the blower power switch is on.
- Make sure the 6 amp circuit breaker is set. (See page 58 for details)
- Make sure the connection at the blower base pan is fully connected. (Especially if the blower base pan has been removed recently.)
- Possible faulty blower switch.
- Possible faulty blower.

### Blower operates slowly:

- Air filter may be clogged. Replace with new one. (See page 57)
- Blower may need to be oiled. (See page 56)
- Have the console's casters been removed or is the console sitting on thick carpet? If so, there might not be enough air flow under the console to allow for the free movement of air. Raise the console to allow a greater volume of air to move under the frame.
- Line voltage may be low. If your line voltage is below 108 VAC the blower and mixer motors will run slower and not very efficiently. Check with an electrician to troubleshoot the building's electrical service.

## **Mixer Motor Troubleshooting**

### **Mixer motor stopped working:**

- Check to make sure the console is plugged in and the outlet voltage is sufficient.
- Make sure the mixer motor switch is on.
- Make sure the 6 amp breaker is set. (See page 58 for details)
- Make sure the connection at the blower base pan is fully connected. (Especially if the blower base pan has been removed recently.)
- Possible faulty mixer motor switch.
- Possible faulty mixer motor.

### **Mixer motor running slow:**

- Check to make sure the console is plugged in and the outlet voltage is sufficient.
- Oil the mixer motor. (See page 56)
- Possible faulty mixer motor.

## **Flashboard Output Problems**

### **Flashboard lights flicker**

- Possible loose flashboard data connector. Check all flashboard connections on the console and flashboard.
- Faulty flashboard PCB. (Contact distributor for replacement or repair.)
- Faulty console PCB. (Contact distributor for replacement or repair.)



### **No flashboard response**

- Possible faulty data cable. Check the data cable from the console to the first flashboard to make sure it is in good condition, and replace any damaged cabling. Run a known good cable even if no damage is visible. Of course, if the replacement cable works then the previous cable must have been bad.
- The first flashboard in the chain is bad. The signal coming out of the console might be good, but if the first flashboard in the chain is bad it will not display information and also will not pass the signal on to the other flashboards in the chain. Unplug all data cables from the console and run a known good cable to one of the other flashboards in the chain to check for functionality. If this works, there maybe a worn/damaged/broken flashboard or data cable in the chain. (See above step for a faulty cable.) Check your flashboard distributor or manufacturer about troubleshooting and diagnosing a faulty flashboard.
- 0.1 amp breaker is open. (See page 58 for breaker resetting)

Faulty console printed circuit board. Contact your distributor for repair or replacement.

# Wiring Diagrams & PCB Layouts

## I/O Box, Front Connections



## I/O Box, Rear Connections

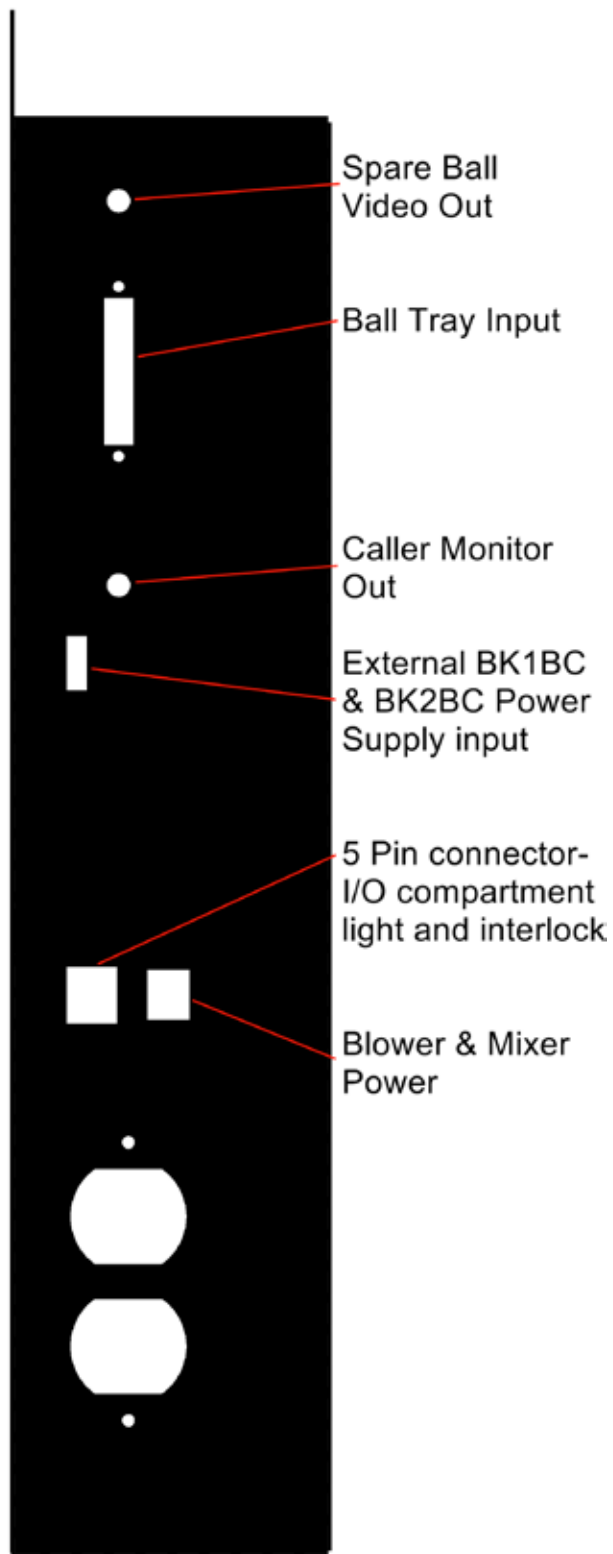

## I/O Box, Top Connections



**BVS PCB**

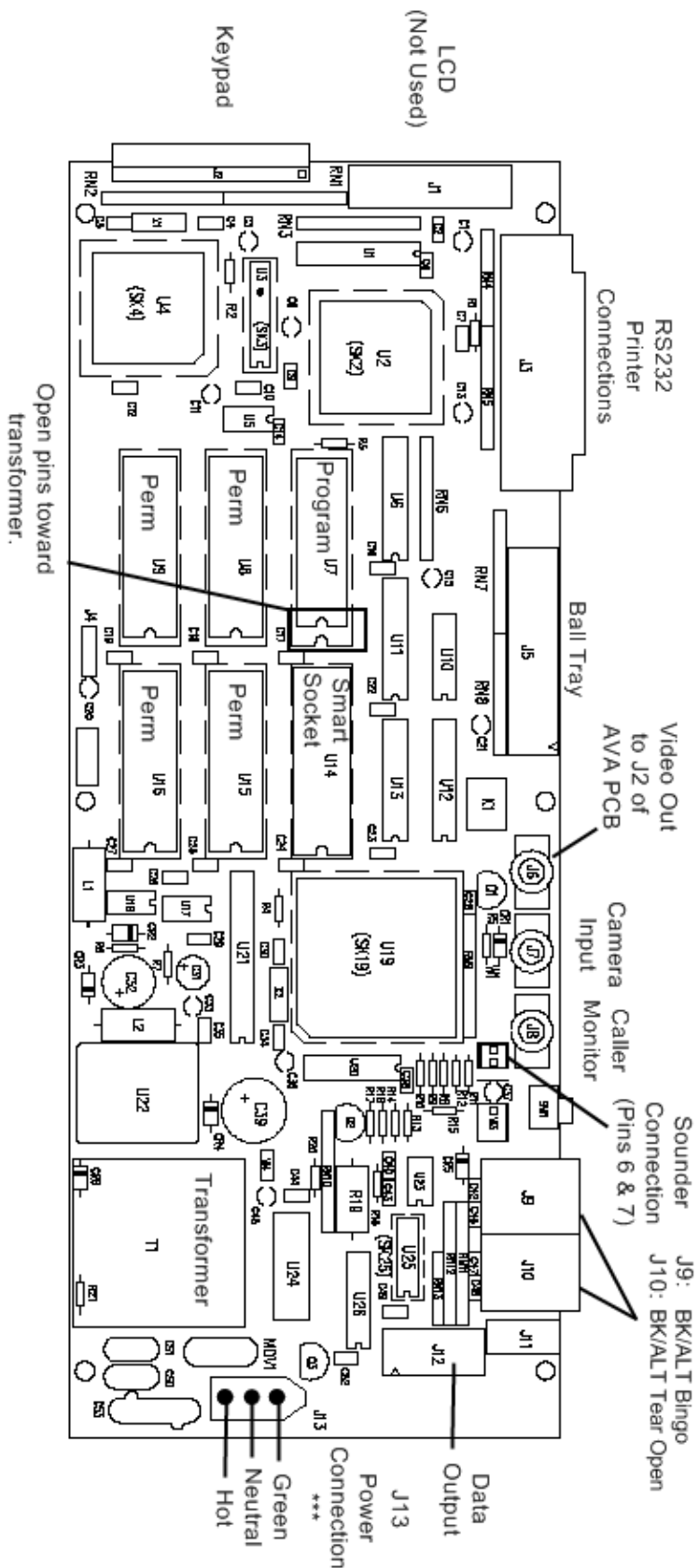

# BK1BC PCB

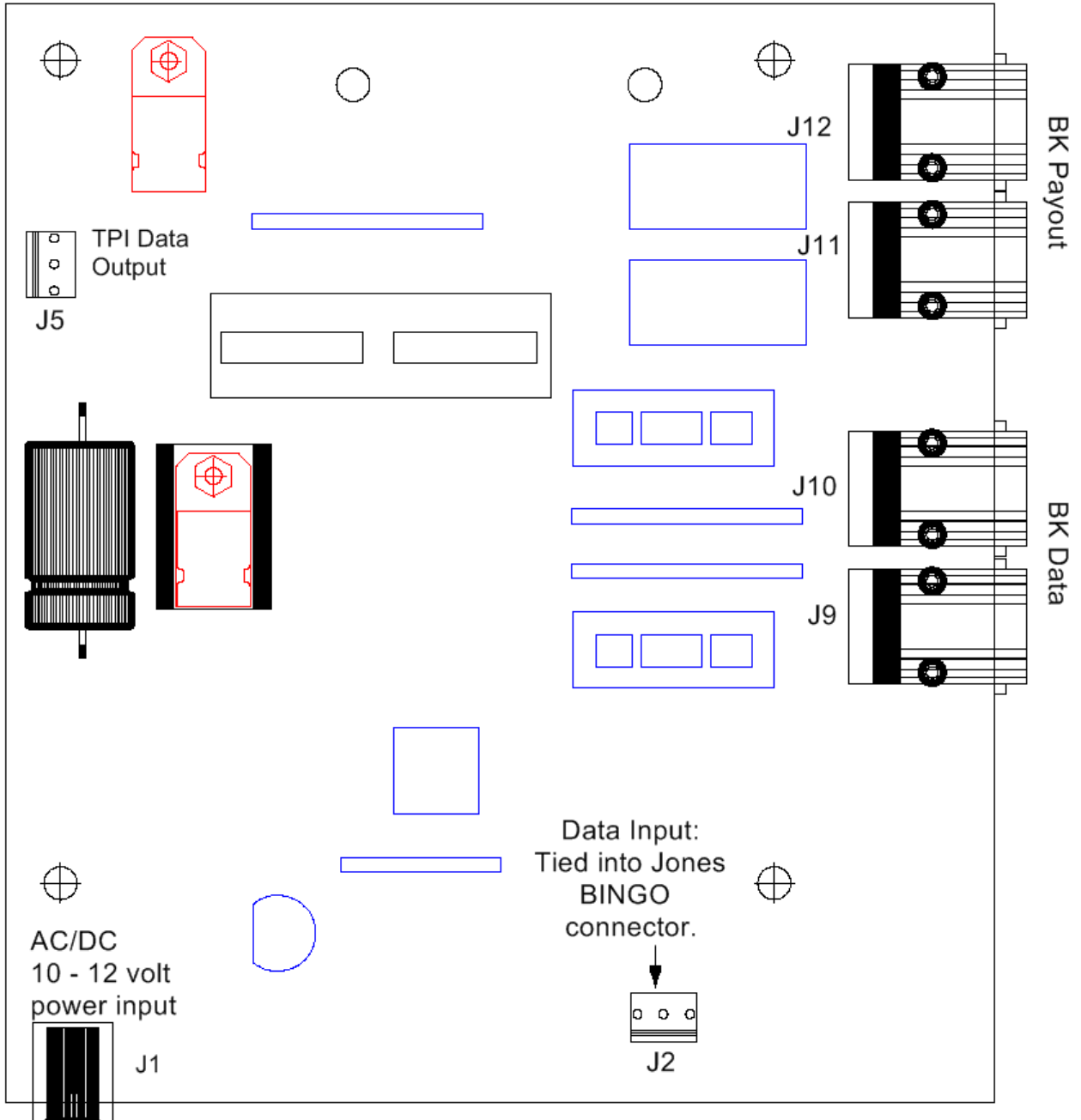

# BK1BC PCB

# BK2BC PCB

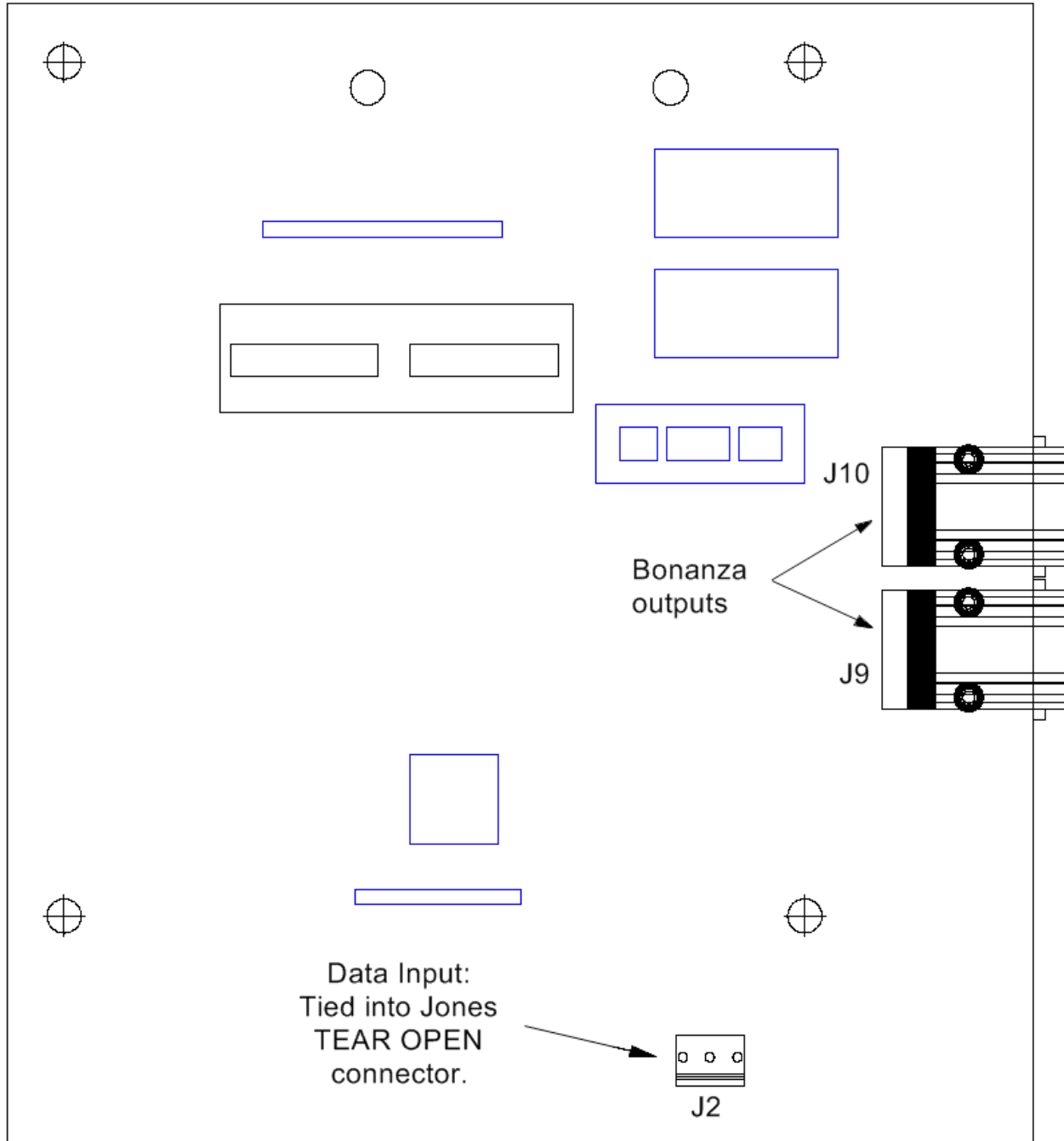

# BK2BC PCB

# AVA PCB

Hall Monitor Output  
(Connected to front  
of I/O panel)

Video Input from  
J6 of BVS PCB

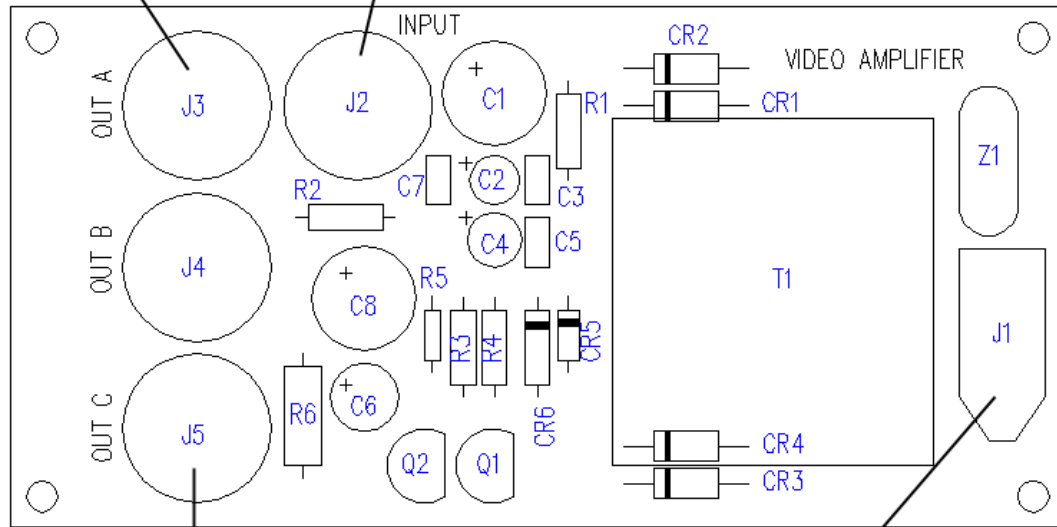

Spare Ball Video Out  
(to back of I/O panel)

Power In



# Warranty

## Chapter

# 9

### **Bingo King® Bingo Console Standard Limited Warranty**

Set out below are the terms of the Standard Limited Warranty (“Limited Warranty”) made by Bingo King Co. (“Bingo King”) in connection with the sale of the Bingo King Bingo® Console (the “Equipment”).

#### **1. Limited Warranty**

Subject to the limitations in the next paragraph, Bingo King warrants to the original purchaser (“Purchaser”) that the Equipment will, to the extent manufactured by Bingo King, be free from defects in material and workmanship for a period of ONE (1) YEAR from the date of shipment of the Equipment from Bingo King. Purchaser represents to Bingo King that no employee, agent, or representative of Bingo King (or a Bingo King dealer) has made any representation or warranty regarding the Equipment except as set out herein.

This Limited Warranty applies to normal commercial use and does not cover failure or damage which (a) occurs in shipment; (b) is caused by products not supplied by Bingo King; or (c) results from accident, misuse, abuse, neglect, mishandling, misapplication, alteration, set-up adjustments or modifications. This Limited Warranty also does not cover any damage resulting from failure to install the Equipment in strict conformity with local fire and building codes and regulations, or if the installation does not comply with the installation instructions provided by Bingo King. Products which are manufactured by a third-party vendor and offered with the Equipment (such as monitors, keyboards, cameras, and other peripheral products) are not covered by this Limited Warranty. Purchaser needs to consult the third-party manufacturer’s warranty for warranty claims related thereto. Bingo King will supply a copy of any third-party vendor’s warranty upon written request.

#### **2. Disclaimer of Warranties**

BINGO KING MAKES NO WARRANTIES, EXPRESS OR IMPLIED (INCLUDING, WITHOUT LIMITATION, MERCHANTABILITY, FITNESS FOR PARTICULAR PURPOSE, OR AGAINST INFRINGEMENT OF ANY PATENT), EXCEPT AS EXPRESSLY PROVIDED HEREIN. THE EXPRESS WARRANTIES PROVIDED HEREIN ARE IN LIEU OF AND EXCLUDE ALL OTHER WARRANTIES, GUARANTEES OR REPRESENTATIONS, EXPRESS OR IMPLIED, WHETHER ARISING BY OPERATION OF LAW OR OTHERWISE.

#### **3. Limitation of Remedies**

If the Equipment does not conform to the Limited Warranty set out above, Bingo King will, at its option, (a) repair or replace the Equipment, or part thereof, which is defective, or (b) refund so much of the purchase price as Purchaser has paid for the defective Equipment, less 1/12th of the purchase price for each month between the date of the purchase from an authorized Bingo King dealer and the date of the discovery of the defect, provided that written notice of the defect and its nature is given to Bingo King as soon as practical after discovery of the defect, but in no event later than 90 days from the date of the discovery of the defect. All part repairs are through the Bingo King Cleveland Depot.

#### **4. Limitation of Liability**

The remedy of repair, replacement, or refund of the purchase price is Purchaser’s sole and exclusive remedy and will satisfy all of Bingo King’s liabilities, whether based on contract, negligence, tort, product liability, strict liability or otherwise. IN NO EVENT WILL BINGO KING BE LIABLE FOR INCIDENTAL OR CONSEQUENTIAL DAMAGES, NOR WILL ITS LIABILITY IN CONNECTION WITH ANY EQUIPMENT OR SERVICE SOLD (INCLUDING NONDELIVERY OR LATE DELIVERY THEREOF) EXCEED THE SALE PRICE OF SUCH EQUIPMENT.

## **5. Warranty Voided**

Any obligations of Bingo King under this Limited Warranty will be deemed to have been satisfied if anyone other than an authorized Bingo King Equipment Dealer services the Equipment.

## **6. Transfer of Limited Warranty**

Purchaser may transfer its rights under this Limited Warranty, subject to the terms and conditions hereof, to a buyer ("Buyer") from Purchaser of the Equipment. Thereafter, the rights under this Limited Warranty are not transferable.

For the transfer by Purchaser of the Limited Warranty to be effective, the following conditions must have occurred no later than the 30th day following the date of resale to Buyer:

- A. Purchaser must have complied with all requirements to make the Limited Warranty effective as to Purchaser; and
- B. The Equipment (as an entire unit and as purchased by Purchaser) must be transferred to Buyer.

Upon an effective transfer of this Limited Warranty, Buyer will be considered to be "Purchaser" for paragraphs 1, 4 and 8 hereof.

## **7. Inspection**

With respect to any claim that the Equipment is defective, Bingo King will be allowed a reasonable time to inspect the Equipment, in place. If the Equipment is altered or removed before Bingo King has made such inspection or waived its right to do so, the obligations of Bingo King under this Limited Warranty will be deemed to have been satisfied.

## **8. Proof of Purchase**

Notwithstanding anything to the contrary in this Limited Warranty, Purchaser must, upon Bingo King's request, submit proof of original purchase (satisfactory to Bingo King) of the Equipment. The Limited Warranty set out above shall not apply to, nor cover, any Equipment for which Purchaser is unable, upon Bingo King's request, to supply such proof of purchase.

## **9. Telephone Support**

Telephone support is available to Purchaser on Mondays through Fridays (including holidays) from 8:00 a.m. until 12:00 a.m. (Eastern Standard Time). The telephone number is (866) 405-3482.

## **10. Preventative Maintenance; Emergency Service**

Purchaser is entitled to request Bingo King to perform, through an authorized Bingo King distributor, one (1) preventative maintenance servicing on the Equipment. The preventative maintenance servicing shall be done in accordance with Bingo King's standard Preventative Maintenance program. Service performed by Bingo King or an Bingo King authorized distributor, which is not covered under its standard Preventative Maintenance program, will be billed to Purchaser.

## **11. Limitation of Actions**

Any legal action against Bingo King for a default of its obligations under this Limited Warranty must be commenced within two (2) years from the date the Equipment was sold by an authorized dealer of the Equipment.



## **12. How to Obtain Service**

If a problem with this Equipment develops during or after the warranty period, proceed as follows:

- A. Refer to your Operator's Manual and follow the Troubleshooting Table within the 'Service Section'.
- B. Contact the authorized Bingo King Equipment Distributor from whom you purchased the Equipment.
- C. Contact the Bingo King telephone support number listed above.

SERVICE CALLS WHICH DO NOT INVOLVE DEFECTIVE MATERIALS OR WORKMANSHIP AS DETERMINED BY BINGO KING IN ITS SOLE DISCRETION ARE NOT COVERED. THE COST OF SUCH SERVICE CALLS IS THE RESPONSIBILITY OF THE PURCHASER.

Bingo King wants you to remain a satisfied customer. If a problem occurs that cannot be resolved to your satisfaction, please contact us immediately, phone one of the numbers listed above or write to:

Bingo King Co.  
c/o National Service Manager  
2807 Lincoln Way  
Lynnwood, WA 98087

Please be sure to include the name, model number, serial number, date of original purchase, and the distributor from whom you purchased the Equipment, as well as any actions taken to correct the problem.



PART # BKCEV1-MNL



Bingo King Co. • 2807 Lincoln Way • Lynnwood, WA 98087 • 425.745.3700